



賀電  
NHD

# CONTROL SOLUTION FOR INDUSTRY



MIRDC  
ISO 9001

3A6Y013



EC Declaration  
of Conformity



TÜV



A004239



C US



US



LISTED



US

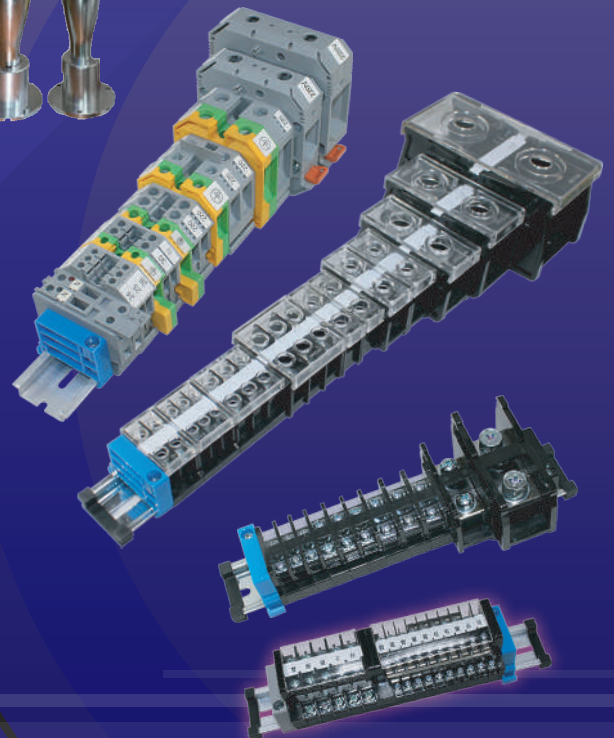
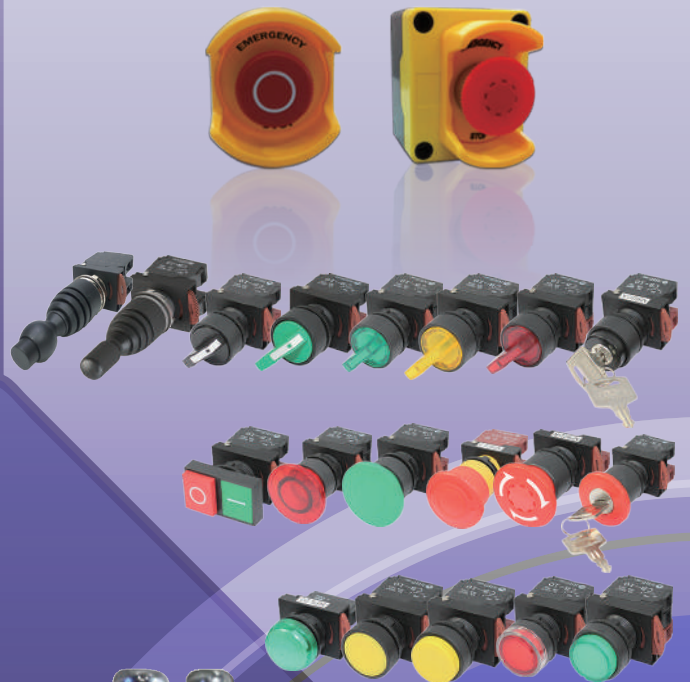
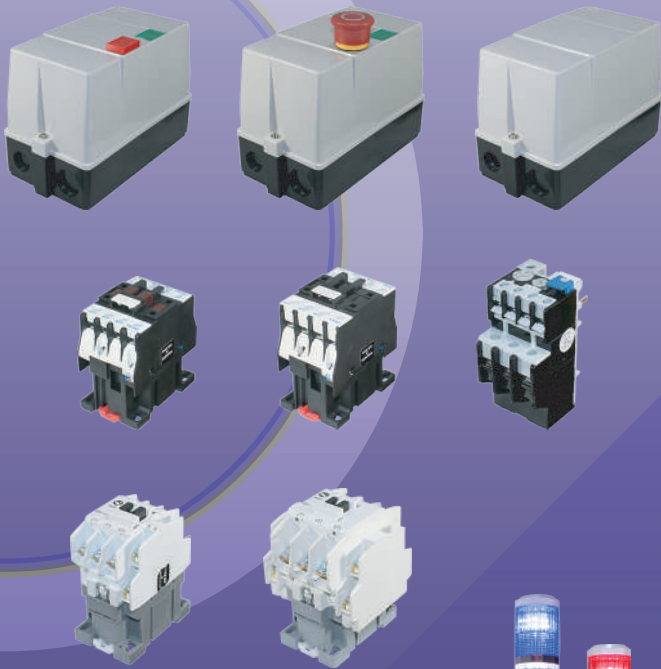



C-06D



C-09D  
C-11D  
C-12D



C-18D



C-25D



C-35D



C-45D  
C-55D  
C-65D



C-80D  
C-100D



MSO-06D



MSO-09D  
MSO-11D  
MSO-12D



MSO-18D



MSO-25D



MSO-35D



NTH-0.5  
NTH-44



NTH-04



NTH-40  
NTH-126



CA1-D11  
CA1-D20  
CA1-D02



CA1-D22  
CA1-D40  
CA1-D31  
CA1-D13  
CA1-D04



CA6-D11  
CA6-D02  
CA6-D20



CA6-D22  
CA6-D40  
CA6-D31  
CA6-D13  
CA6-D04



45D-02C



CA8-D11  
CA8-D02  
CA8-D20



CA9-D02



12D-01A  
(09D~18D)



25D-01A  
(25D~35D)

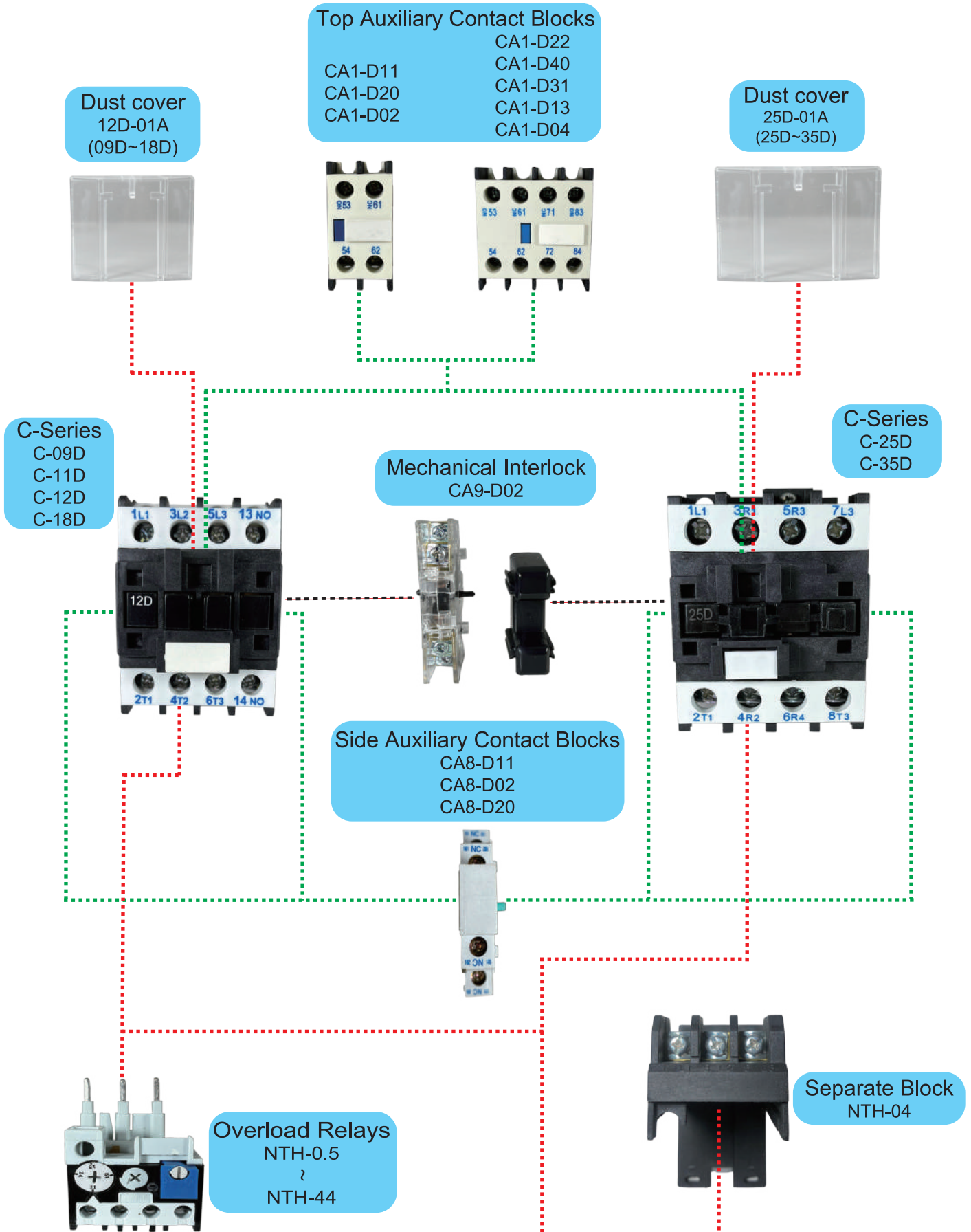



SMC-09  
SMC-12  
SMC-18  
SMC-22



SMC-32  
SMC-40

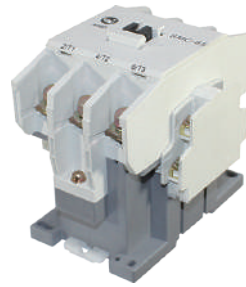

SMC-50  
SMC-65  
SMC-75  
SMC-85



SMC-75B  
SMC-85B  
SMC-100



SMD-09  
SMD-12  
SMD-18  
SMD-22



SMD-32  
SMD-40

DC 24V  
DC 110V  
DC 220V



SMC-09-01A  
(SMC-09~SMC-100)



SMC-IN9



MSO-S09  
MSO-S12  
MSO-S18  
MSO-S22



MSO-S32  
MSO-S40



MSO-S09 DC  
MSO-S12 DC  
MSO-S18 DC  
MSO-S22 DC



MSO-S32 DC  
MSO-S40 DC



SMC-D11



SMC-T11



CA2-D11  
CA2-D20  
CA2-D02



CA4-D22  
CA4-D40  
CA4-D31  
CA4-D13  
CA4-D04

**Top Auxiliary Contact Blocks**

CA2-D11  
CA2-D20  
CA2-D02

CA4-D22  
CA4-D40  
CA4-D31  
CA4-D13  
CA4-D04



**Dust cover**  
SMC-09-01A  
(SMC-09~SMC-100)



**SMC-Series**  
CONTROL CIRCUIT : AC  
SMC-09  
SMC-12  
SMC-18  
SMC-22

**SMC-Series**  
CONTROL CIRCUIT : AC  
SMC-32  
SMC-40

**SMD-Series**  
CONTROL CIRCUIT : DC  
SMD-09  
SMD-12  
SMD-18  
SMD-22

**SMD-Series**  
CONTROL CIRCUIT : DC  
SMD-32  
SMD-40

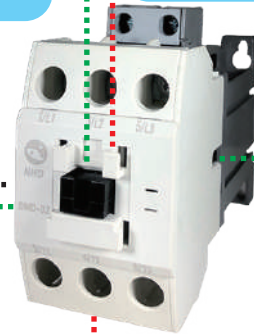
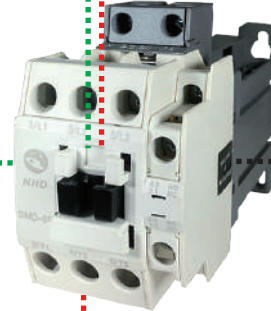
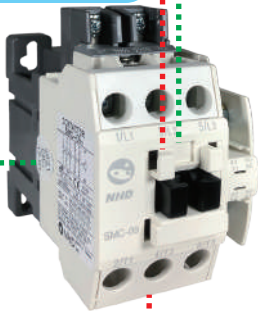

**Mechanical Interlock**  
SMC-IN9



**Side Auxiliary Contact Block**  
SMC-D11



**Overload Relays**  
NTH-0.5  
NTH-44



**Separate Block**  
NTH-04





S-C100  
S-C125

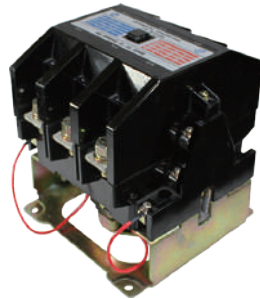

S-C150



TH-60T



TH-120

1 Pole



SCREW  
AC201  
AC251  
AC301  
AC401  
AC501

2 Pole



SCREW  
AC202  
AC252  
AC302  
AC402  
AC502

3 Pole



SCREW  
AC203  
AC253  
AC303  
AC403  
AC503

4 Pole



SCREW  
AC204  
AC254  
AC304  
AC404  
AC504

1 Pole



SCREW+PIN  
AC201 AC251 AC301 AC401 AC501



BOX LUG+PIN

2 Pole

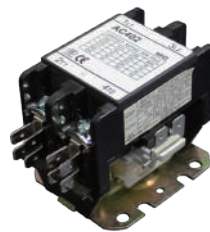

SCREW+PIN  
AC202 AC252 AC302 AC402 AC502



BOX LUG+PIN

3 Pole



SCREW+PIN  
AC203 AC253 AC303 AC403 AC503



BOX LUG+PIN

4 Pole



SCREW+PIN  
AC204 AC254 AC304 AC404 AC504



BOX LUG+PIN

IP65



MS1-09D  
MS1-11D  
MS1-12D  
MS1-18D

IP65



MS1-25D  
MS1-35D

IP65



MS-09D  
MS-11D  
MS-12D  
MS-18D

IP65



MS-25D  
MS-35D

IP65



MS1-09D-R  
MS1-11D-R  
MS1-12D-R  
MS1-18D-R

IP65



MS1-25D-R  
MS1-35D-R



MS1



MS



MS1-R



IP42



MSP11-09D  
MSP11-11D  
MSP11-12D

IP42



MSP21-09D  
MSP21-11D  
MSP21-12D  
MSP21-18D

IP42



MSP35-25D  
MSP35-35D  
MSP35-45D  
MSP35-S32  
MSP35-S40  
MSP35-S50

IP42



MSP11-09D-PB  
MSP11-11D-PB  
MSP11-12D-PB

IP42



MSP21-09D-PB  
MSP21-11D-PB  
MSP21-12D-PB  
MSP21-18D-PB

IP42



MSP35-25D-PB  
MSP35-35D-PB  
MSP35-45D-PB  
MSP35-S32-PB  
MSP35-S40-PB  
MSP35-S50-PB



MSP35-25D  
MSP35-35D  
MSP35-45D



MSP35-S32  
MSP35-S40  
MSP35-S50



MSP35-25D-PB  
MSP35-35D-PB  
MSP35-45D-PB



MSP35-S32-PB  
MSP35-S40-PB  
MSP35-S50-PB





NPL22-G  
● ● ● ● ●



NLD22-R  
● ● ● ● ● ●



NPB22-F  
NPB22-L  
● ● ● ● ● ●



NPB22-E  
NPB22-P  
● ● ● ● ● ●



NLB22-F  
NLB22-L  
● ● ● ● ●



NLB22-E  
NLB22-P  
● ● ● ● ● ●



NPB22-D



NLB22-D  
For BA9-R · G · Y · S · W



NPB22-DM



NLB22-DM  
For BA9-R · G · Y · S · W



NPB22-M  
NPB22-G  
● ● ●



NLB22-M  
NLB22-G  
● ● ●



NPB22-M6  
● ● ●



NPB22-H



NPB22-I



NPB22-J



NPB22-K



NPB22-R



NLB22-R



NPB22-T



NLB22-T



NPB22-T6



NSS22-S2  
● ● ● ●



NSS22-S3  
● ● ● ●



NSS22-L2  
● ● ● ●



NSS22-L3  
● ● ● ●



NLS22-L2  
● ● ● ●



NLS22-S2  
● ● ● ●



NSS22-K2



NSS22-K3



NJS22N-M22A



NJS22K-R44A





NFP series



JCB-11L



JCB-11R



CB-11



CB-10



CB-01



NPB22-SB



NPB22-SB2



PPB22-F06



PPB22-P06



PPB22-D06



PPB22-DM06



NFP-H



EMO-01  
● ○



EMO-02  
● ○



EMO-03  
●



EMO-04  
●



NPB22-R01C-E



NPB22-R02C-E



NPB30-R03C-E



NPB22-R01C-C



NPB22-R02C-C



NBZ22-RA



PPB22-02T



LED BULB  
for BA9 / BA9-X / BA9-L



NPB22-H06L



NPB30-H06L



NPB22-E06L

ANTI-INTERFERENCE  
BULB HOLDER

Patent Number : M429166



BA9  
BA9-X  
(ANTI-INTERFERENCE)



BA9-L

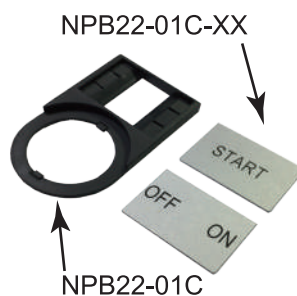

NPB22-01C-XX

NPB22-01C

Mounting Adaptor  
from 22mm to 30mm  
NPB30-01

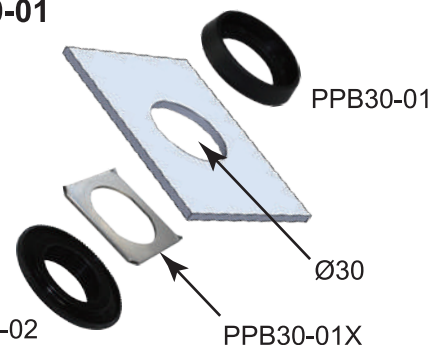

PPB30-01

Ø30

PPB30-02

PPB30-01X



NPB160-E  
NPB160-P  
● ● ●  
● ● ●



NLB160-E  
NLB160-P  
● ● ●  
● ●



NPB16S-F  
NPB16S-L  
● ● ●  
● ● ●



NLB16S-F  
NLB16S-L  
● ● ●  
● ●



NPB16T-F  
NPB16T-L  
● ● ●  
● ● ●



NLB16T-F  
NLB16T-L  
● ● ●  
● ●



NLD160  
● ● ●  
○



NPB160-M  
NPB160-G



NSS160-S



NSS16S-S



NSS16T-S



NSS160-K



NSS16S-K



NSS16T-K



NPB160-R



NLD16-TT



NPB16-TT



NPB16-CP



NPB16-CS

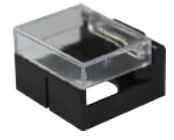

NPB16-CT



C1Y-001



C1W-001



C1W-002



C1Y-003



C1W-003



C1Y-004



C1Y-005



C2Y-001



C2Y-003



C3Y-002



C3W-002



C4Y-004



C4Y-005



C5Y-001



NB22-C1Y ●  
NB22-C1W ○



NB22-C2Y ●  
NB22-C2W ○



NB22-C3Y ●  
NB22-C3W ○



NB22-C4Y ●  
NB22-C4W ○



NB22-C5Y ●  
NB22-C5W ○

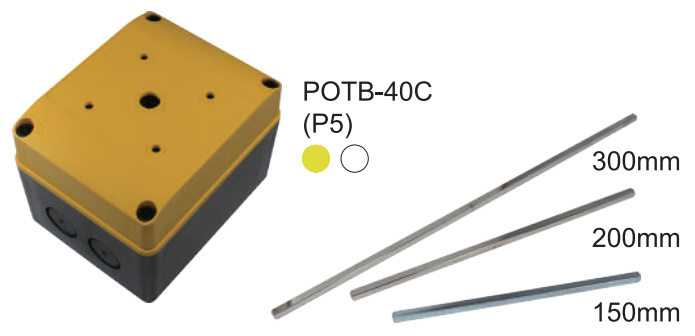
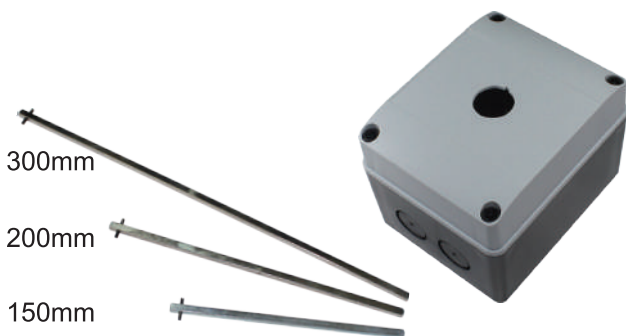
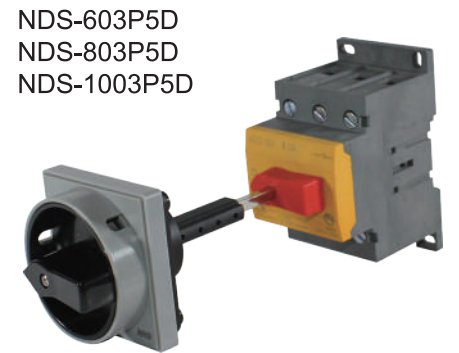
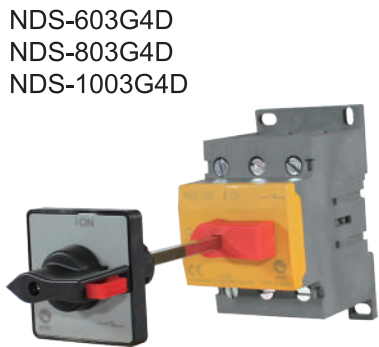
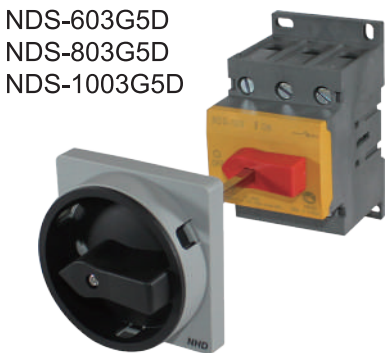
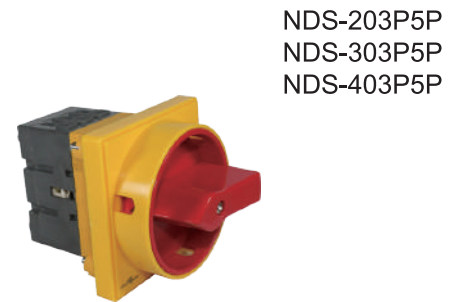
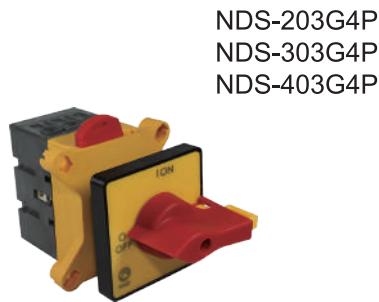
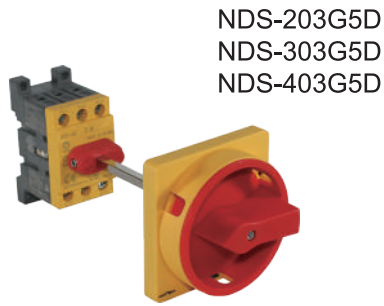

**CAM SWITCHES**

MOUNTING HOLE : 36x36mm , 48x48mm , 22mm , 30mm  
 VOLTMETER SWITCH      AMMETER SWITCH  
 MOTOR REVERSING SWITCH  
 ON / OFF SWITCH      CHANGEOVER SWITCH  
 MULTI-STEP SWITCH  
 CAPACITY : 10A · 16A · 25A · 32A · 63A · 80A · 100A



**LED TOWER LAMP**

AC/DC 24V  
 AC 100V~120V  
 AC 220V~240V

**METAL TYPE  
LED TOWER LAMP**

DC 24V



NTL-F

NTL-R

NTL-T

NTL-W

NTLA-F

## TERMINAL BLOCKS

SCREW CLAMP TERMINAL BLOCKS

FUSE TERMINAL BLOCKS

CASSETTE ASSEMBLY TERMINAL BLOCKS

FEED-THROUGH TERMINALS AND ASSEMBLIES

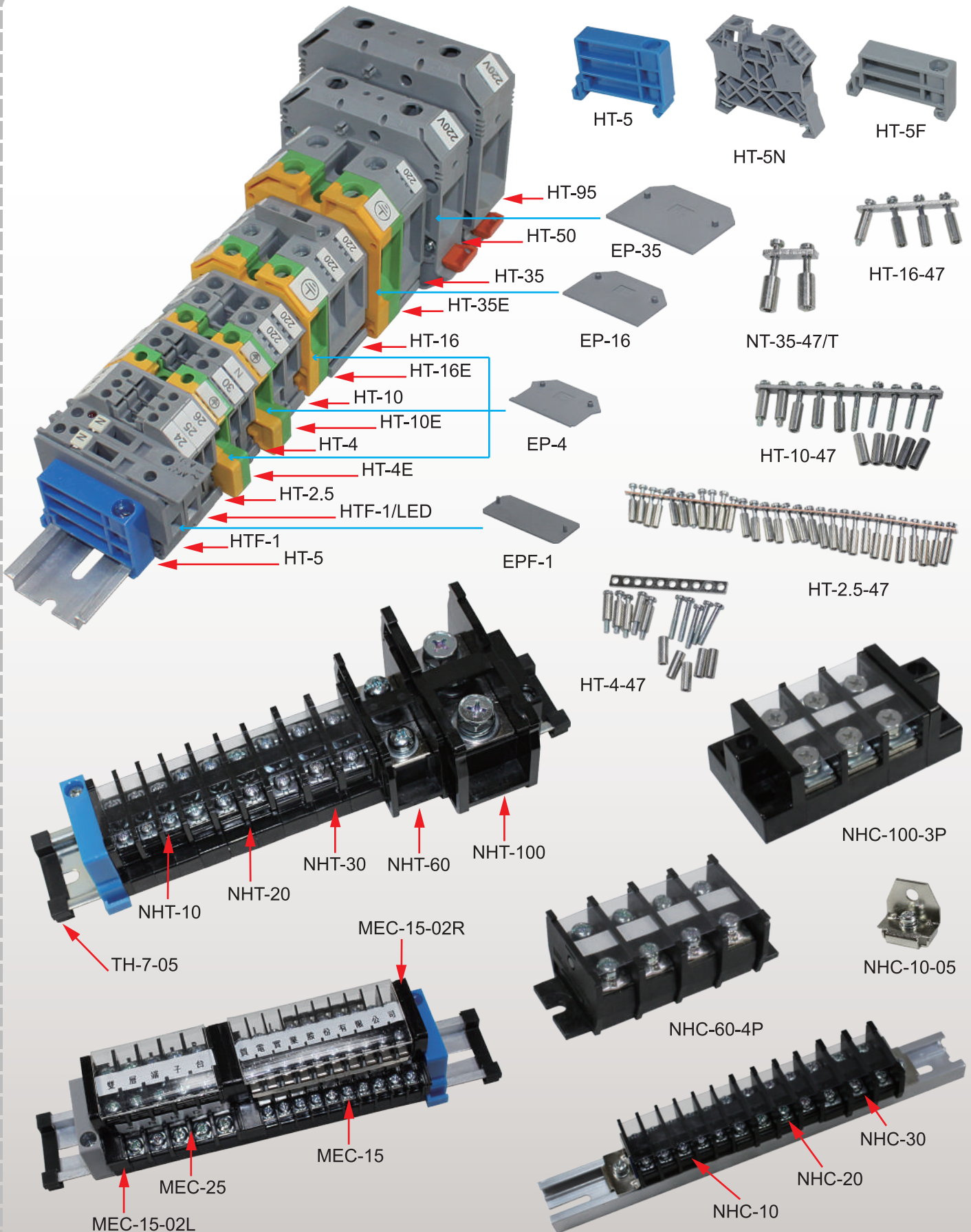

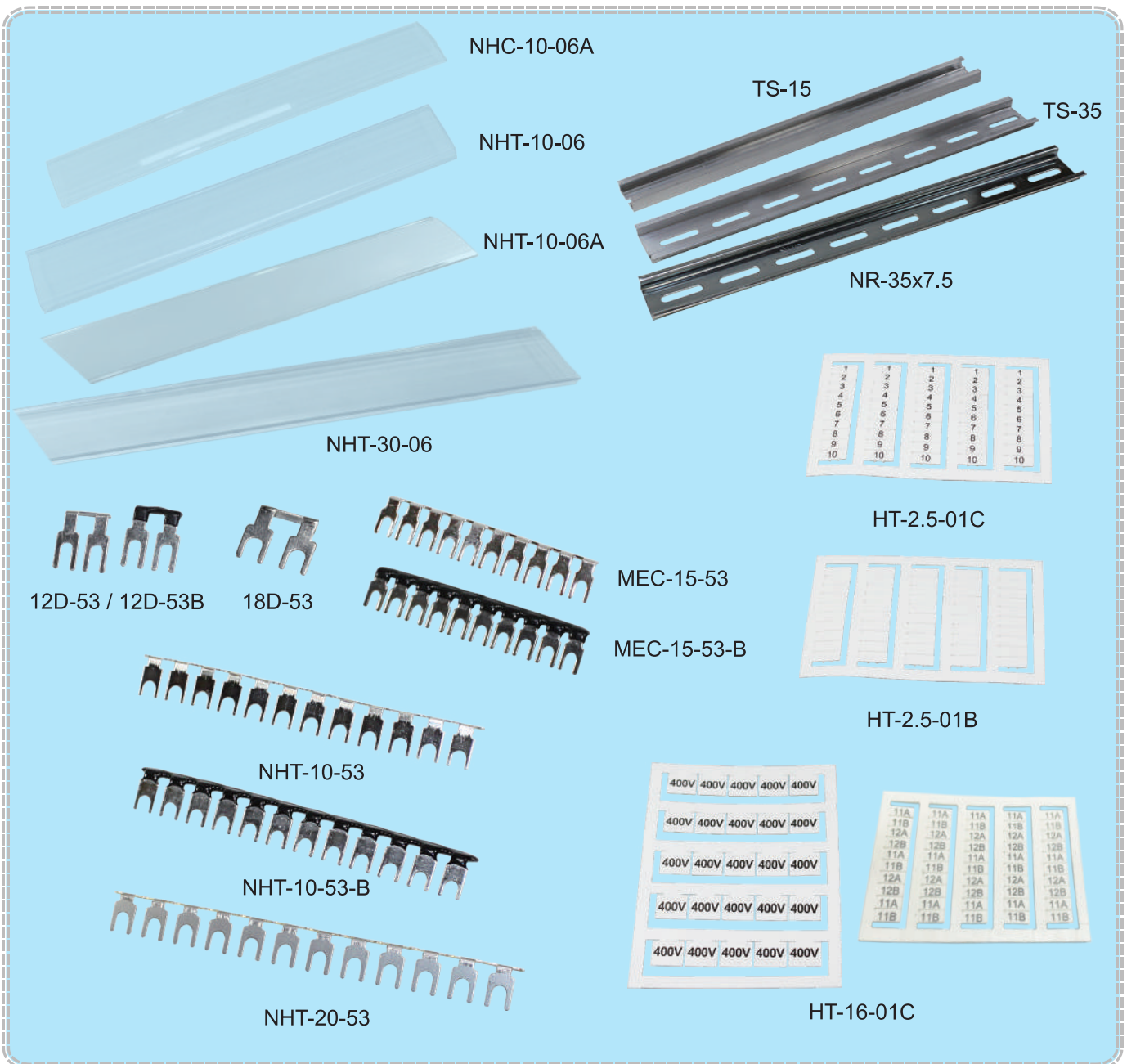
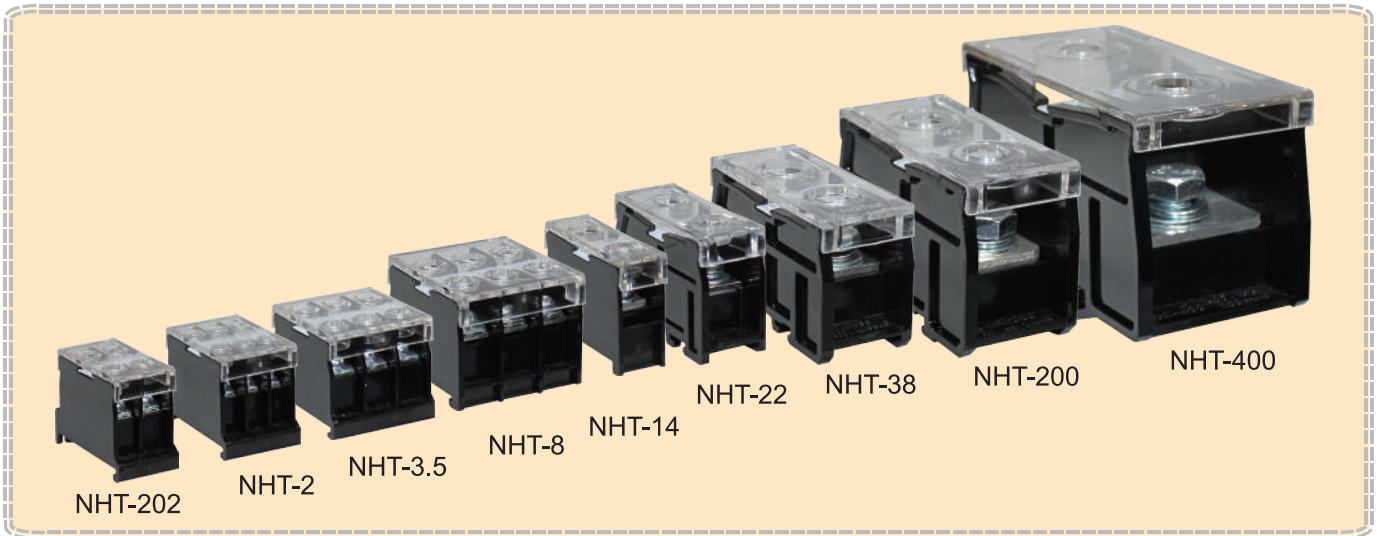



## 賀電實業股份有限公司

**NHD INDUSTRIAL CO., LTD.**

No.47, Lane 268, Hsin Hsu Road,  
Hsin Chuang Dist., New Taipei City, Taiwan.

TEL:886-2-2203-5265 FAX:886-2-2203-7157

E-mail:nhdi@ms15.hinet.net

URL:<http://www.nhdi.com.tw/>



我們亦可委託加工或專業設計"低壓配電盤"及"自動控制系統"，歡迎不吝與我們聯絡  
We also have the OEM & ODM service for low voltage switchgear and the automatic control system. Please don't hesitate to contact us.