

# SPM-3 Multi-Function Power Meter

## 多功能數位電力表



### User guide

### 使用手冊

士林電機廠股份有限公司 Shihlin Electric Corporation  
新竹縣湖口鄉鳳凰村中華路二十三號.  
電話：886-3-598-1921 傳真：886-3-598-1480  
網址：[www.seec.com.tw](http://www.seec.com.tw)

## 目錄

### 第一章 產品介紹

#### 1.1 SPM-3 簡介

#### 1.2 安全須知

##### 1.2.1 危險注意

##### 1.2.2 產品保固及售後服務

#### 1.3 產品規格

### 第二章 安裝及接線

#### 2.1 產品檢查

#### 2.2 產品安裝

##### 2.2.1 產品外型

### 第三章 線路接線圖

#### 3.1 背面接線

##### 3.1.1 輔助電源

##### 3.1.2 數位輸出 Digital Output

##### 3.1.3 電流輸入端子

##### 3.1.4 電壓輸入端子

#### 3.2 接線圖

##### 3.2.1 單相二線式/1CT

##### 3.2.2 單相三線式/2CT

##### 3.2.3 三相三線式/2CT

##### 3.2.4 三相三線式/3CT

##### 3.2.5 三相四線式/3CT

### 第四章 面板顯示及設定

#### 4.1 面板顯示

#### 4.2 執行期模式

##### 4.2.1 按鍵 M

##### 4.2.2 按鍵 P

##### 4.2.3 按鍵 E/T

##### 4.2.4 按鍵 V/A

#### 4.3 設定期模式

##### 4.3.1 一般設定 N

##### 4.3.2 清除設定 C

##### 4.3.3 警報設定 A

#### 4.4 特殊功能按鍵

### 第五章 通訊

#### 5.1 RS485

##### 5.1.1 RS485 標準

##### 5.1.2 儀器通訊接線

#### 5.2 Modbus

##### 5.2.1 Modbus 的格式

#### 5.3 通訊協定

#### 5.4 浮點格式

#### 5.5 Modbus RTU Mode

#### 5.6 Modbus Function Code

#### 5.7 通訊參數明細

## 第一章 產品介紹

### 1.1 SPM-3 簡介

SPM-3 為一高精度多功能電表，可應用於一般單、三相系統之電力監視量測、分析、儲存，具有完整的電力量測功能，包括電流、電壓、電量、瓦特、功因、瓦時、頻率、需量，有效及無效電能計算等。

其產品特色如下：

- 符合 IEC62053-22 Class 0.5 規範
- 精度高，V.I.精度優於 0.2%，Wh 精度優於 0.5%，可做雙向電能量測。
- 量測項目超過 90 項。
- 電流反接時，可於設定中直接調整電流流向，不需重新配線。
- 大尺寸 LCD 顯示螢幕，背光亮度可做 4 段式調整，操作靈敏，易學易用。
- 具備 RS-485 通訊介面，支援 Modbus 標準通訊協定，應用彈性大。
- 具備電壓/電流不平衡率、電壓合格率等電力品質量測項目。
- 外型小巧，符合 DIN96\*96 標準，採自鎖式安裝卡榫，安裝拆卸皆方便。

### 1.2 安全須知



#### 1.2.1 危險注意

請注意！！

只有合格的安裝人員可以安裝這台設備。請在閱讀本指示之後再進行安裝工作。

適當的安裝及操作將有利於此產品之運作。忽視基本的安裝要求可能導致人身傷害和對電氣設備或者其他財產的損害。在進行安裝及維修此產品前，請研讀手冊，並熟悉安裝順序及注意事項。請特別注意本產品之電力系統，考慮到其所有可能性。

請注意這些警告，否則將導致嚴重的人身傷害或使設備受到損害。

#### 1.2.2 產品保固及售後服務

士林電機廠股份有限公司對本產品及其材料的保固期限為一年。在保固期內，我們會對有瑕疵的產品進行維修。請在產品送修時提供產品型號、序號及詳細敘述故障問題。若有需要請電：**+886-3-5981921**

## 1.3 電表規格

### 1.3.1 功能表

一般量測
電流(三相, 平均, 中性*) 電壓(L-L 電壓, L-N 電壓, 平均) 頻率 Hz 電力/kW, kVAR, kVA(三相, 總和) 功率因素 (三相*, 總和)
電能量測
電能/kWh, kVARh, kVAh 雙向計量
需能量測
kW 需量, kVAR/kVA 需量* 電流需量* 需量模式:定時區(Block), 移動平均式(Rolling)
電力品質
電壓/電流總諧波量測 電壓/電流單次諧波量測, 可達 31 階*(經由通訊讀取) 電壓/電流不平衡量測 電壓合格率 相角* (Va-Vx, Va-Ix, x=a, b,c)
資料記錄
量測參數之最大最小值 警報(過電壓警報, 過電流警報, 過頻率警報, 過 kW 需量警報, 低電壓警報, 低電流警報, 低頻率警報)
輸出輸入接點 I/O
DO(2DO)
通訊 Communication
RS485(主要通訊埠) 第二組 RS485(次要通訊埠, 選配)
*為進階版具備功能

### 1.3.2 技術規格表

量測接線模式	3P4W, 3P3W-2CT, 3P3W-3CT, 1P3W, 1P2W, 自動判斷接線模式
取樣率	3600 點/秒
精度	電壓:0.2% 電流:0.2% 電力/kW, kVAR, kVA:0.5 % 電能/kWh, kVARh, kVAh:0.5 % 功率因素 Power Factor:0.5% 頻率 Frequency:0.1% 總諧波 Total Harmonic Distortion:1.0% 單次諧波 Individual Harmonics:1.0%
輔助電源	80-380 VAC/100-300VDC
功耗	0.7W/4.5VA (背光關閉) 1.5W/6VA (背光開啓最大時) 1.8W/7VA (背光開啓最大時及附加 LON 模組)
量測輸入範圍	PT 一次側:60-60000V PT 二次側:1-600V CT 一次側:1-9999A CT 二次側:1-5A 頻率:47-63Hz
DO 數位輸出	數位輸出: 2 組, 可作為警報或 kW pulse 輸出, 12~240Vac-dc/ 120mA max

通訊	主要通訊埠：RS485 Modbus protocol, 2-wire, 4800~57600bps 次要通訊埠：第二組 RS485(選配)
安裝方式	盤面式固定
尺寸(mm)	96(W) × 96(H) × 97(L)
重量	0.6Kg
顯示	68X59 Monochrome LCD
工作溫度	- 20 ~ 70 °C
儲存溫度	- 25 ~ 80 °C
濕度(RH, %)	95%
保護等級	IP52(前面板) IP20(背殼)
認證規範	1.LVD Test Report : EN61010-1 2.CE Test Report : EN61326 Conducted Emission EN61326 Radiated Emission EN61000-3-2 Harmonic Current Emission EN61000-3-3 Voltage Fluctuation and Flicker EN61000-4-2 Electrostatic Discharge EN61000-4-3 Radiated Susceptibility EN61000-4-4 Electrical Fast Transient/Burst EN61000-4-5 Surge EN61000-4-6 Conducted Susceptibility EN61000-4-8 Power Frequency magnetic Field EN61000-4-11 Voltage Dips and Interruption 3.FCC Test Report : Class A and CISPR 22

\*CATIII-Is for measurement performed on circuits directly connected to the low voltage installation

### 1.3.3 訂購資訊

SPM-3   -   
          1    2    3

#### 1.類型

- 0：標準版
- 1：進階版

#### 2.次要通訊埠

- 0：無次要通訊埠
- 1：第二組 RS485(選配)

#### 3.CT 選項

<u>CT 規格</u>	<u>CT 規格</u>
5A	內建 5A CT
10A	CTΦ10mm, 10mA~10A
60A	CTΦ10mm, 25mA~60A
100A	CTΦ16mm, 50mA~100A
200A	CTΦ24mm, 100mA~200A

## 第二章 安裝及接線

### 2.1 產品檢查

如果打開包裝後發現產品有損壞，使用者應立刻連絡出貨商。產品拆封時請小心不要損害到儀器，並將產品包裝盒保留，作為日後搬運之用。

### 2.2 產品安裝



請使用柔軟的乾布作為清潔，不要使用化學物品、清潔劑之類的揮發性溶劑清潔設備，以免造成外殼損傷。

- 建議安裝在無振動之盤面，周圍環境溫度為 $-20^{\circ}\text{C}$ 至 $70^{\circ}\text{C}$ ，溼度為20至90%RH(無凝結)。
- 安裝時，請於電表前端，加裝符合現場環境耐電壓規格、1A的保險絲。
- 維護本表時，務必要確實拆除所有的電源連接線。
- 維護必須由合格及有被授權人員來執行。
- 面板 IP52，表殼 IP20 保護等級。

#### 2.2.1 產品外型

正視圖(單位 mm)

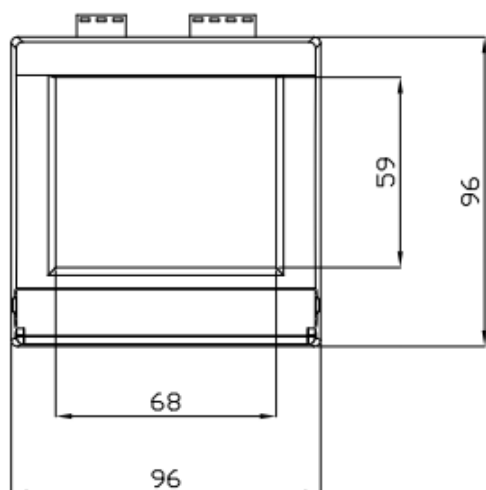

背視圖(單位 mm)

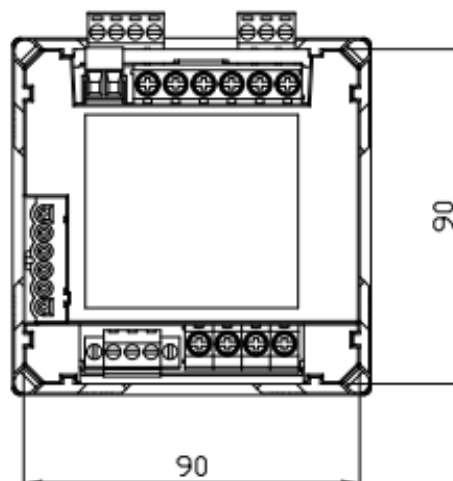

側視圖(單位 mm)

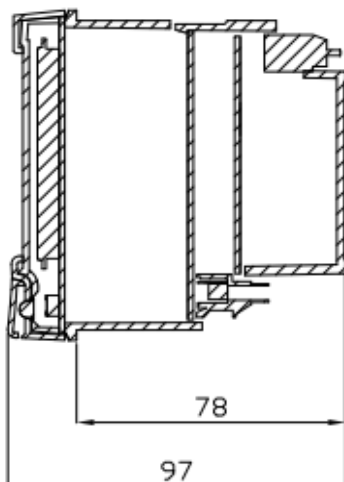

安裝於盤面之後，再將四個卡榫裝上以固定。建議盤面割孔為  $91.5 \times 91.5 (+/-0.5)$  mm

## 第三章 線路接線圖

### 3.1 背面接線

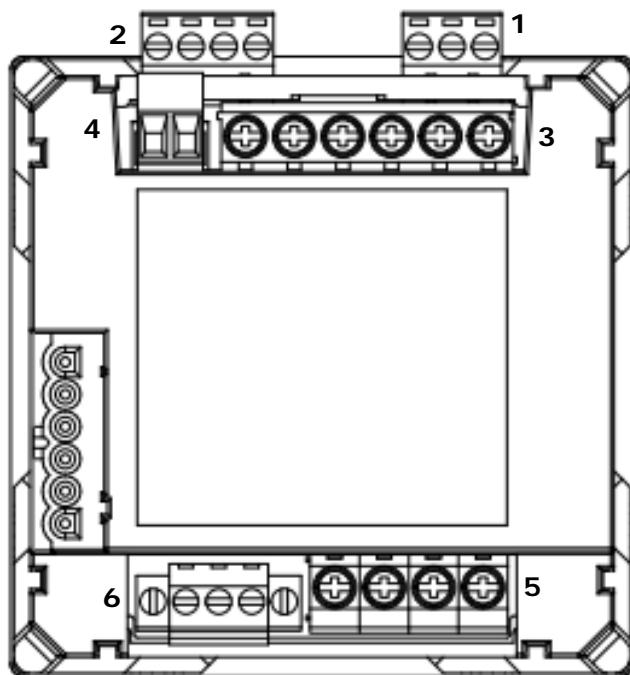

1. 輔助電源(N-, ,L+)
2. 數位輸出 (Com2 DO2 Com1 DO1)
3. 電流輸入端子 (3L 3S 2L 2S 1L 1S)
4. Lon 埠(D-,D+)
5. 電壓輸入端子 (N,C,B,A)
6. RS485 埠 (D-,COM,D+)

#### 3.1.1 輔助電源

- 在送電之前，必須檢查電源線插入正確的 pin 腳位置(N, ,L)、直流電(-, ,+)。
- 標準電源 80-380 Vac/100-300Vdc。
- 本儀表電源不必接地。



小心：若接直流電源,(-, ,+)位置勿接錯。

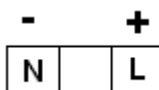

#### 3.1.2 數位輸出 Digital Output

- 2 埠 4 pin 輸出(Com2 DO2 Com1 DO1)。
- 需外接電源 12-240VAC-DC/120mA max。
- 數位輸出的 port-1 接腳是 Com1 DO1；數位輸出的 port-2 接腳是 Com2 DO2。
- 數位輸出的 port-1 功能選擇：無(NONE)、任何警報(ANY)、過電壓/電流警報(OVER V/I)、過頻率警報(OVER F)、過 kW 需量警報(OVER Dmd)、低電壓/電流警報(UNDER V/I)、低頻率警報(UNDER F)。
- 數位輸出的 port-2 功能選擇：可選擇脈衝輸出或警報項目，其輸出之脈衝頻率依 Kh(pulse/kWh)之設定而定，並可設定警報項目(與 DO1 相同)。

#### 3.1.3 電流輸入端子 (內建 5A)

- 電流輸入端子有 3 組 6 處端子(3L 3S 2L 2S 1L 1S)。
- SPM-3 電流輸入為 CT 二次側 8mA~5A。



小心：CT 電流輸入端最大電流不可超過 10A。

 小心：在量測電流中，CT 電流輸入端接線在電源未斷路前，不能先卸除 CT 電流輸入端接線，否則產生開路導致危險。

### 3.1.4 電壓輸入端子

- 電壓輸入端子有 4 處端子(N,C,B,A)。
- SPM-3 電壓輸入為 10V~600V RMS (相-相)(PT 二次側)。
- 不可超過 600 V 電壓，超過此界限須用 PT，務必確定一/二次側 PT 之 RATIO。

 注意！若為三相三線式/2CT 及三相三線式/3CT 之電壓輸入端接法為“**A N C**”，  
N 取代 B 接。

↓ ↓ ↓  
L1 L2 L3

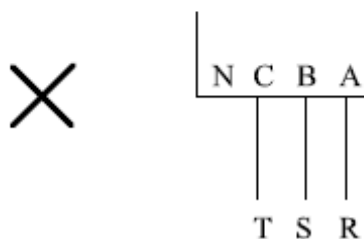
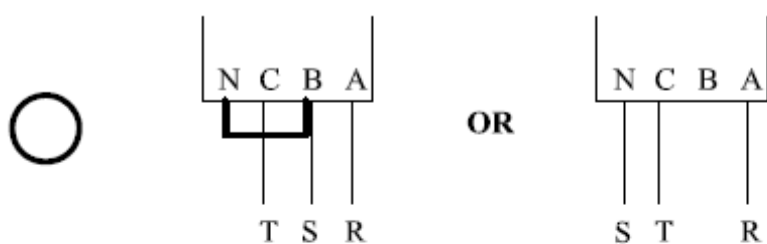



### 3.2 接線圖 (內建 5A)

#### 3.2.1 單相二線式/1CT

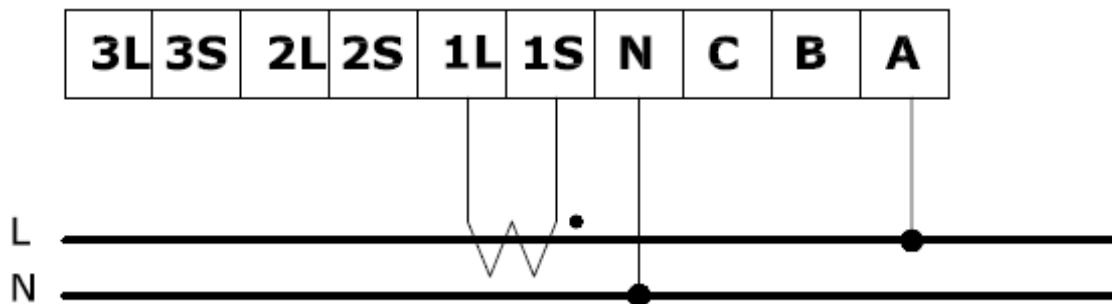

#### 3.2.2 單相三線式/2CT

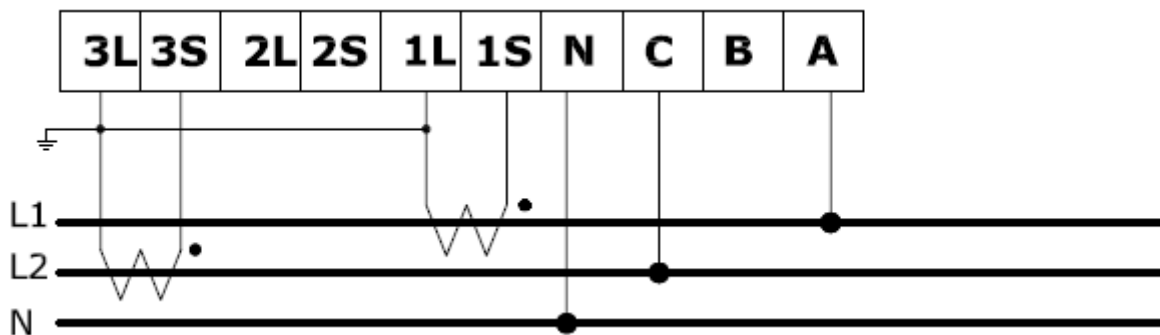

#### 3.2.3 三相三線式/2CT

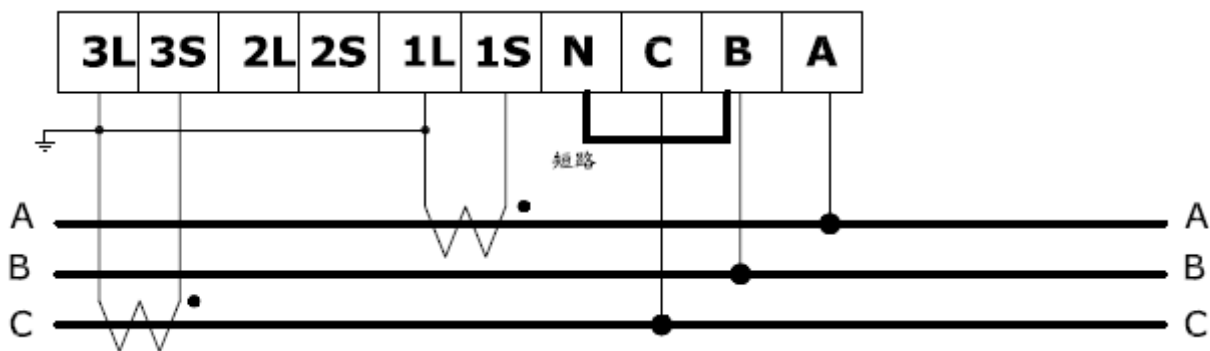

3.2.4 三相三線式/3CT

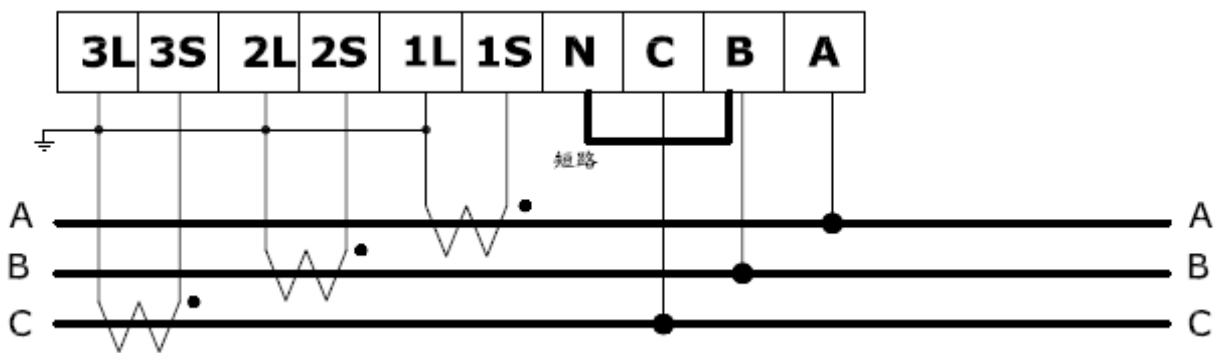

3.2.5 三相四線式/3CT

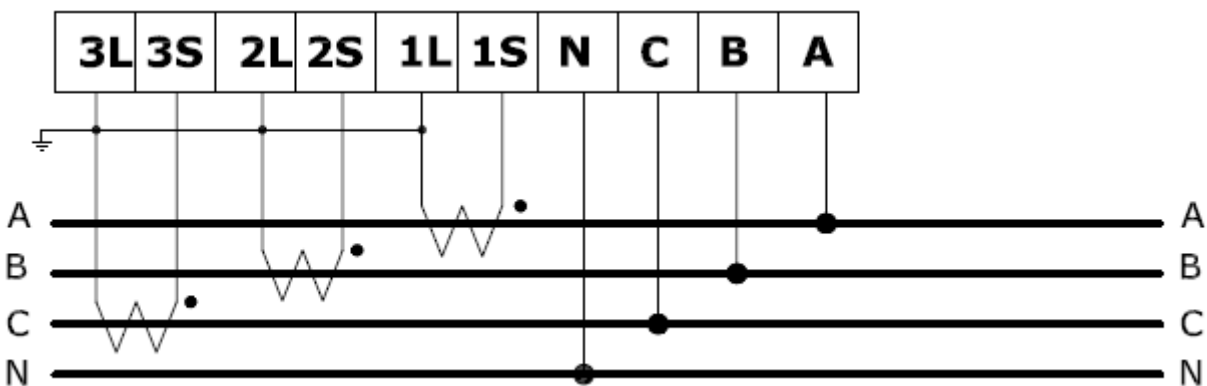

## 第四章 面板顯示及設定

### 4.1 面板顯示

本表主要是由一個液晶顯示螢幕及 4 個按鍵組成，在正常工作狀況下，會於螢幕顯示各即時量測值，下圖顯示為液晶螢幕全被點亮時之畫面。

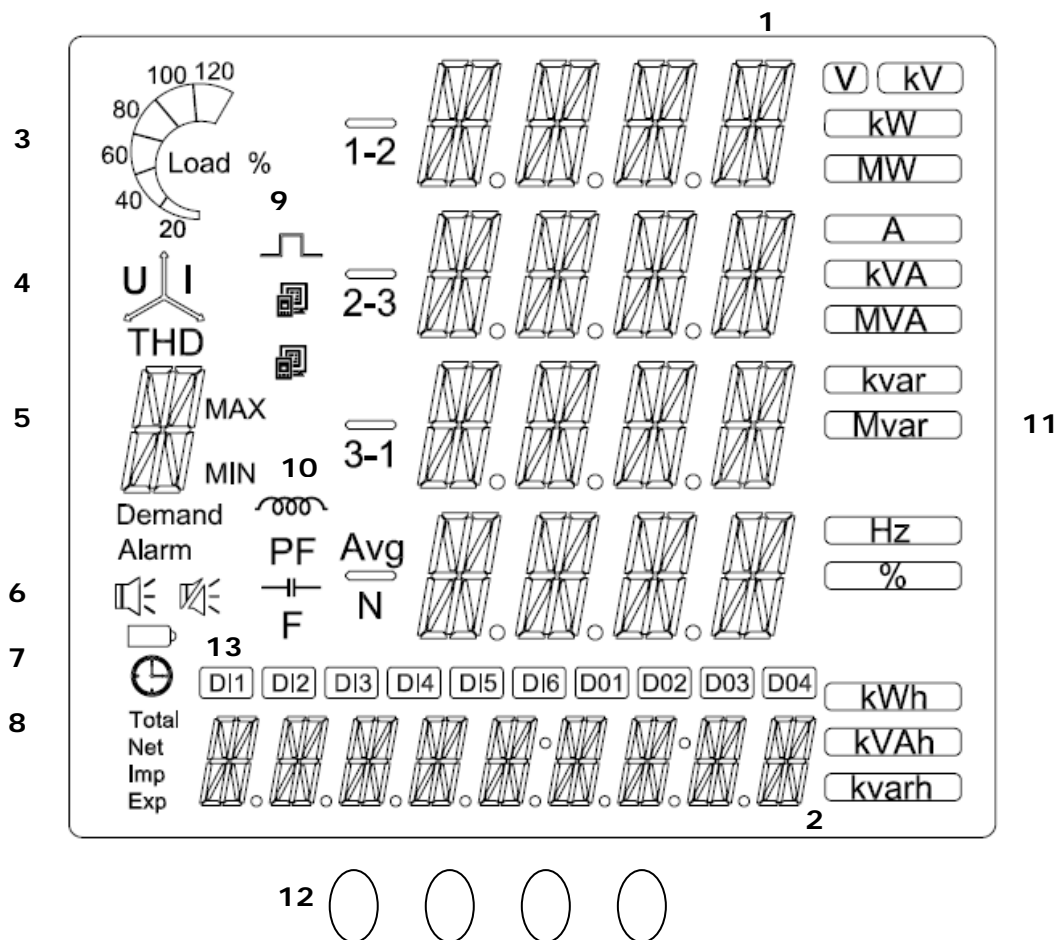

編號	顯示內容
1	顯示主要量測參數，包含 V, I, kW, kvar,kVA,PF, Frequency, Demand, 合格率, 不平衡率
2	顯示電能參數及時間
3	負載大小指示圖
4	不平衡率及總諧波失真顯示
5	量測參數標識符號，會依照主要參數區之量測顯示 V, I...等符號
6	顯示蜂鳴器之開啓或關閉
7	此時鐘標示點亮時，於編號 2 之電能參數及時間顯示區會顯示真實時鐘
8	顯示總電能
9	顯示脈衝，通訊狀態
10	顯示功因，頻率，電容性負載或電感性負載
11	顯示各量測參數之單位
12	4 組按鍵由左至右為『M』、『P』、『E/T』、『V/A』
13	顯示 DO1、DO2 狀態

\*\*\*DI、DO3、DO4 功能暫不提供

## 4.2 執行期模式

本機共有 4 個按鍵，由左到右分別為『M』、『P』、『E/T』、『V/A』，透過此 4 個按鍵的操作可以顯示不同的量測參數及進行參數設定。在執行期功能如下，

- 按鍵 M：顯示最大最小值
- 按鍵 P：顯示各相及總和 Power，PF(功率因素)，F(頻率)，kW 需量，kVA 需量\*，kvar 需量\*
- 按鍵 E/T：顯示電能(Energy)，RTC 時間
- 按鍵 V/A：顯示電壓電流(V/A)，電壓電流不平衡率，電壓合格率，總諧波失真，電流需量\*

### 4.2.1 按鍵 M

選按『M』鍵，可顯示目前參數之最大最小值，每按鍵一次，即依序切換最大值/最小值/即時值，各參數最大/最小內容如下

- L-L 電壓 (1-2,2-3, 3-1)(最大/最小)  
L-L 平均電壓 (Avg)(最大/最小)
- L-N 電壓 (1,2, 3)(最大/最小)  
L-N 平均電壓 (Avg)(最大/最小)
- 三相電流 (1, 2, 3)(最大/最小)  
三相平均電流 (Avg)(最大/最小)
- 電壓電流不平衡率(最大/最小)
- kW 有效功率 (1, 2, 3)(最大/最小)  
kW-t 總有效功率(最大/最小)
- kvar 無效功率 (1, 2, 3)(最大/最小)  
kvar-t 總無效功率(最大/最小)
- kVA 視在功率 (1, 2, 3)(最大/最小)  
kVA-t 總視在功率(最大/最小)
- kW-t 總有效功率(最大/最小)  
kVA-t 總視在功率(最大/最小)  
kvar-t 總無效功率(最大/最小)  
PF 功率因素(最小)
- kW-t 總有效功率(最大/最小)  
kVA-t 總視在功率(最大/最小)  
kvar-t 總無效功率(最大/最小)  
F 頻率(最大/最小)
- Power Demand kW 前次需量(最大)  
(空白)  
目前需量子區間剩餘時間(秒)  
Power Demand kW 目前需量
- Power Demand kvar 前次需量(最大) \*  
(空白)  
目前需量子區間剩餘時間(秒)  
Power Demand kvar 目前需量
- Power Demand kVA 前次需量(最大) \*  
(空白)  
目前需量子區間剩餘時間(秒)  
Power Demand kVA 目前需量
- I Demand 電流需量 前次需量(1,2,3)(最大)\*
- I Demand 電流需量 目前需量(1,2,3)(最大)\*  
目前需量子區間剩餘時間(秒)

### 4.2.2 按鍵 P

選按『P』鍵，可依序顯示各相/總和 Power、PF(功率因素)、F(頻率)、kW demand(電力需量)、kVA demand(視在需量\*)、kvar demand(乏需量\*)，每按鍵一次，即向下翻動一頁，顯示內容如下

- kW 有效功率 (1, 2, 3)  
kW-t 總有效功率
- kvar 無效功率 (1, 2, 3)

- var-t 總無效功率
- kVA 視在功率 (1, 2, 3)
- kVA-t 總視在功率
- kW-t 總有效功率(標準版顯示)
- kVA-t 總視在功率(標準版顯示)
- kvar-t 總無效功率(標準版顯示)
- PF 功率因素(標準版顯示)
- PF 功率因素(1, 2, 3)(進階版顯示)
- PF 總功率因素(進階版顯示)
- kW-t 總有效功率
- kVA-t 總視在功率
- kvar-t 總無效功率
- F 頻率
- Power Demand kW 前次需量  
(空白)
- 目前需量子區間剩餘時間(秒)
- Power Demand kW 目前需量
- Power Demand kvar 前次需量\*
- (空白)
- 目前需量子區間剩餘時間(秒)
- Power Demand kvar 目前需量
- Power Demand kVA 前次需量\*
- (空白)
- 目前需量子區間剩餘時間(秒)
- Power Demand kVA 目前需量

#### 4.2.3 按鍵 E/T

選按『E/T』鍵，可依序顯示各電能總和及時間項目，每按鍵一次，即向下翻動一頁，顯示內容如下

- kWh-t 總有效電能
- kvarh-t 總無效電能
- kVAh-t 總視在電能
- 年月日顯示
- 時分秒顯示

#### 4.2.4 按鍵 V/A

選按『V/A』鍵，可依序顯示電壓電流相關參數，每按鍵一次，即向下翻動一頁，顯示內容如下

- L-L 電壓 (1-2,2-3, 3-1)
- L-L 平均電壓 (Avg)
- L-N 電壓 (1,2, 3)
- L-N 平均電壓 (Avg)
- 三相電流 (1, 2, 3)，電流值<10000 時，顯示 0.000~9999，當電流值>10000 時，則顯示 10.00~999.9(單位為 1000)
- 三相平均電流 (Avg)
- 電壓電流不平衡率
- 電壓合格率
- 電壓總諧波失真
- 電流總諧波失真
- 電壓(Va-Vx) 角度 (x=a,b,c) \*
- 電流(Va-Ix) 角度 (x=a,b,c) \*
- 三相電流需量(前次)\*
- 三相電流需量(目次)\*

\*為進階版具備功能

### 4.3 設定期模式

在任何執行期模式下，同時按住『M』及『V/A』鍵將進入設定模式。在設定模式下：

- 『M』鍵用於移動游標，每按一次游標即向右移一位，同時游標所在的位數會閃動顯示。
- 『P』鍵為『減一』鍵，每按一次，則游標所在位置執行『減一』操作，滿 10 歸零。
- 『E/T』鍵為『加一』鍵，每按一次，則游標所在位置執行『加一』操作，滿 10 歸零。
- 『V/A』鍵為『確認』鍵，每按一次，則對輸入的內容進行確認，並同時翻頁到下一設定項目。
- 在任一設定頁面，同時按住『M』及『V/A』鍵則返回設定選擇首頁，再同時按『M』及『V/A』鍵則退出設定模式。

同時按住『M』及『V/A』鍵，進入

密碼詢問

PASS

WORD

0000

P0：設定選擇首頁，可選擇 **BASIC** 一般設定(N)，**ALARM** 警報/IO 設定(A)，**CLEAR** 清除功能設定(C)

P0

MAIN

MENU

BASIC / ALARM+I/O / CLEAR

#### 4.3.1 一般設定 N

**N1：儀表位址設定-可設定 1-255(出廠值設 15)**

N1

Add

015

**N2：BAUD RATE 設定-可選擇 4800，9600，19200，38400，57600 (出廠值設 19200)**

N2

BAUD

RATE

19200

**N3：停止位元 Stop Bit-可選擇『1』或『2』(出廠值設 1)**

N3

STOP

BIT

1

**N4：接線方式-可選擇 1P2W，1P3W，3P3W-2CT，3P3W-3CT，3P4W-Y，AUTO(出廠值設 AUTO)**

N4

WIRE

TYPE

3P4W

**N5：PT 一次側設定-可設定 60-600000(出廠值設 110)**

N5

PT1

000110

**N6：PT 二次側設定-可設定 1-600(出廠值設 110)**

N6

PT2

110

**N7：CT 一次側設定-可設定 1-9999(出廠值設 1)**

N7

CT1

0001

**N8 : CT 二次側設定-可設定 1-5(出廠值設 1)**

N8  
CT2  
1

**N9 : 背光熄滅時間設定-可設定 0-120 分鐘(出廠值設 1)。**

設為 0 時，背光長亮；設為其他值時，若此時間內無任何按鍵動作，背光自動熄滅。背光熄滅後按任一按鍵即可點亮背光。

N9  
BACK  
LIT  
120

**N10 : 背光亮度設定-可設定 0-4 (出廠值設 3)。**

設為 0 時，關閉背光

N10  
BACK  
LIT  
LVL  
3

**N11 : 電流 L1 流向設定-可選擇 POSITIVE，NEGATIVE (出廠值設 POSITIVE)**

為調整電流接線錯誤，3 組電流可分別設正向及反向。如果實際電流接反，可選擇反向『NEGATIVE』，則電表會輸出正確結果。選『POSITIVE』則表示接線正常

N11  
I-1  
POSITIVE

**N12 : 電流 L2 流向設定-可選擇 POSITIVE，NEGATIVE (出廠值設 POSITIVE)**

為調整電流接線錯誤，3 組電流可分別設正向及反向。如果實際電流接反，可選擇反向『NEGATIVE』，則電表會輸出正確結果。選『POSITIVE』則表示接線正常

N12  
I-2  
POSITIVE

**N13 : 電流 L3 流向設定-可選擇 POSITIVE，NEGATIVE (出廠值設 POSITIVE)**

為調整電流接線錯誤，3 組電流可分別設正向及反向。如果實際電流接反，可選擇反向『NEGATIVE』，則電表會輸出正確結果。選『POSITIVE』則表示接線正常

N13  
I-3  
POSITIVE

**N14 : V1(V12)電壓合格率上限(二次側)-可設定 0-65535(Scale 0.1) (出廠值設 65535)**

N14  
U1  
UP  
LMT  
65535

**N15 : V1(V12)電壓合格率下限(二次側)-可設定 0-65535(Scale 0.1) (出廠值設 0)**

N15  
U1  
LOW  
LMT  
00000

**N16 : V2(V23)電壓合格率上限(二次側)-可設定 0-65535(Scale 0.1) (出廠值設 65535)**

N16  
U2  
UP

LMT  
65535

**N17 : V2(V23)電壓合格率下限(二次側)-可設定 0-65535(Scale 0.1) (出廠值設 0)**

N17  
U2  
LOW  
LMT  
00000

**N18 : V3(V31)電壓合格率上限(二次側)-可設定 0-65535(Scale 0.1) (出廠值設 65535)**

N18  
U3  
UP  
LMT  
65535

**N19 : V3(V31)電壓合格率下限(二次側)-可設定 0-65535(Scale 0.1) (出廠值設 0)**

N19  
U3  
LOW  
LMT  
00000

**N20 : 需量計算方式選擇-可選擇固定式(BLOCK)或滾動式(ROLLING) (出廠值設 BLOCK)**

N20  
DMD  
MODE  
BLOCK

**N21 : 需量子區間數-可選擇 1.2.3.4.5.6.10 , 僅用於滾動式(出廠值設 1)**

N21  
SUB  
INTV  
NUM  
1

**N22 : 需量子區間時距-可選擇 1.2.3.4.5.6.10.12.15.20.30.60(出廠值設 15)**

N22  
SUB  
INTV  
LENG  
15

**N23 : 年月日設定-可設定日期**

N23  
DATE  
2009.02.20

**N24 : 時分秒設定-可設定時間**

N24  
TIME  
00:00:00

**N25 : 密碼設定-可設定密碼共 4 位數 0000-FFFF(出廠值設 0000)**

N25  
PASS  
WORD  
0000



#### 4.3.2 清除設定 C

**C1：電能復歸 Energy Reset-可選擇『YES』或『NO』，可清除 kWh, kvarh, kVAh**

C1  
ENRG  
RST  
NO

**C2：整表復歸 Reset All-可選擇『YES』或『NO』，可清除電能，運轉積時，需量，最大最小記錄，電壓合格率復歸**

C2  
RST  
ALL  
NO

**C3：開機運轉積時清除(total)-可選擇『YES』或『NO』(目前暫不提供此一功能)，將儀表運轉積時歸零**

C3  
RST  
R-HR  
TOT  
NO

**C4：負載運轉積時清除(net)-可選擇『YES』或『NO』(目前暫不提供此一功能)，將供電系統運轉(負載)積時歸零**

C4  
RST  
R-HR  
NET  
NO

**C5：需量復歸 demand reset-可選擇『YES』或『NO』，清除 Demand 資料，Demand Interval 重新計算**

C5  
RST  
DMD  
NO

**C6：最大最小清除 Period reset-可選擇『YES』或『NO』，清除最大最小記錄**

C6  
RST  
MAX  
MIN  
NO

**C7：回出廠值 Reset to default-可選擇『YES』或『NO』，基本參數恢復為出廠設定值**

C7  
RST  
DEFT  
NO

**C8：電壓合格率 Reset Voltage eligibility rate 清除-可選擇『YES』或『NO』，清除電壓合格率累計，重新計算**

C8  
RST  
VER  
NO

### 4.3.3 警報設定 A

**A1：警報功能開啓選擇**-可選擇『ON』、『OFF』(出廠值設 OFF)。選擇警報是否開啓，選『ON』警報開啓，選『OFF』則警報關閉

A1  
ALRM  
OFF

**A2：蜂鳴器功能開啓選擇**-可選擇『ON』、『OFF』(出廠值設 OFF)。選擇警報時蜂鳴器是否開啓，選『ON』蜂鳴器開啓，選『OFF』則蜂鳴器關閉

A2  
BUZZ  
OFF

**A3：DO1 警報輸出選擇**-可選擇『NONE』、『ANY』、『OVER V』、『OVER I』、『OVER F』、『OVER DMD』、『UNDER V』、『UNDER I』、『UNDER F』(出廠值設 NONE)

A3  
DO1  
ALRM  
NONE

**A4：DO2 輸出選擇**-可選擇『PULSE』或『ALARM』(出廠值設 PULSE)

A4  
DO2  
OUT  
PUT  
PULSE /ALARM

**A5：DO2 警報輸出選擇**-可選擇『NONE』、『ANY』、『OVER V』、『OVER I』、『OVER F』、『OVER DMD』、『UNDER V』、『UNDER I』、『UNDER F』(出廠值設 NONE)

A5  
DO2  
ALRM  
NONE

**A6：脈衝輸出選擇**-可選擇『NONE』、『kWh』、『kvarh』、『kVAh』(出廠值設 NONE)

A6  
PULS  
OUT  
PUT  
NONE

**A7：脈衝常數選擇**-可設定 1-6000(出廠值設 10)。為 DO2 輸出每個脈衝所代表電度數值，1 代表 0.1 kWh /kvarh/ kVAh，預設值 10 為 1 kWh /kvarh/ kVAh。本脈衝輸出值對應為一次側值(乘上 PT/CT 比)。脈衝輸出固定寬度為 20ms，二脈衝輸出之間最小間隔 20ms，即脈衝輸出週期最小為 40ms(25Hz)，設定脈衝常數(kh)時需滿足以下式子，才不至於漏失脈衝：

當脈衝輸出選擇為 kWh 時  $kh \geq P_{max} / 9000000$  (P：三相 watt 總和)， $P_{max}$  為可能最大值

當脈衝輸出選擇為 kvarh 時  $kh \geq Q_{max} / 9000000$  (Q：三相 var 總和)

當脈衝輸出選擇為 kVAh 時  $kh \geq S_{max} / 9000000$  (S：三相 VA 總和)

A7  
kh  
0001

**A8：過電壓警報設定開啓/關閉**-可選擇『ENABLE』或『DISABLE』(出廠值設 DISABLE)

A8  
OVER  
V  
DISABLE

**A9：過電流警報設定開啓/關閉-可選擇『ENABLE』或『DISABLE』(出廠值設 DISABLE)**

A9  
OVER  
|  
DISABLE

**A10：過頻率警報設定開啓/關閉-可選擇『ENABLE』或『DISABLE』(出廠值設 DISABLE)**

A10  
OVER  
FREQ  
DISABLE

**A11：過需量警報設定開啓/關閉-可選擇『ENABLE』或『DISABLE』(出廠值設 DISABLE)**

A11  
OVER  
DMD  
DISABLE

**A12：低電壓警報設定開啓/關閉-可選擇『ENABLE』或『DISABLE』(出廠值設 DISABLE)**

A12  
UNDE  
V  
DISABLE

**A13：低電流警報設定開啓/關閉-可選擇『ENABLE』或『DISABLE』(出廠值設 DISABLE)**

A13  
UNDE  
|  
DISABLE

**A14：低頻率警報設定開啓/關閉-可選擇『ENABLE』或『DISABLE』(出廠值設 DISABLE)**

A14  
UNDE  
FREQ  
DISABLE

**A15：過電壓警報設定點-可設定 0-600000(出廠值設 600000)**

A15  
OVER  
V  
SET  
600000

**A16：過電壓警報解除點-可設定 0-600000(出廠值設 0)**

A16  
OVER  
V  
CLR  
0000000

**A17：過電流警報設定點-可設定 0-9999(出廠值設 9999)**

A17  
OVER  
|  
SET  
9999

**A18：過電流警報解除點-可設定 0-9999(出廠值設 0)**

A18  
OVER

I  
CLR  
0000  
**A19：過頻率警報設定點-可設定 45-65(出廠值設 65)，可設定到小數點一位**  
A19  
OVER  
FREQ  
SET  
63

**A20：過頻率警報解除點-可設定 45-65(出廠值設 45)，可設定到小數點一位**  
A20  
OVER  
FREQ  
CLR  
43

**A21：過需量警報設定點-可設定 0-65535 kW(出廠值設 65535)**  
A21  
OVER  
DMD  
SET  
65535

**A22：過需量警報解除點-可設定 0-65535 kW(出廠值設 0)**  
A22  
OVER  
DMD  
CLR  
00000

**A23：低電壓警報設定點-可設定 0-600000(出廠值設 0)**  
A23  
UNDE  
V  
SET  
000000

**A24：低電壓警報解除點-可設定 0-600000(出廠值設 600000)**  
A24  
UNDE  
V  
CLR  
600000

**A25：低電流警報設定點-可設定 0-9999(出廠值設 0)**  
A25  
UNDE  
I  
SET  
0000

**A26：低電流警報解除點-可設定 0-9999(出廠值設 9999)**  
A26  
UNDE  
I  
CLR  
9999

**A27**：低頻率警報設定點-可設定 45-65(出廠值設 45) ，可設定到小數點一位

A27  
UNDE  
FREQ  
SET  
45

**A28**：低頻率警報解除點-可設定 45-65(出廠值設 65) ，可設定到小數點一位

A28  
UNDE  
FREQ  
CLR  
65

#### 4.4 特殊功能按鍵

- 進入設定功能：執行期按 **M+V/A**
- 顯示電表序號及程式版本：執行期按 **P+E/T**
- **LON module service pin**：執行期按 **E/T+V/A**

## 第五章 通訊

### 5.1 RS485

#### 5.1.1 RS485 標準

參數	
Mode of Operation	Differential
Number of Drivers and Receives	32 Drivers / 32 Receivers
Maximum cable length( meters)	1200
Maximum data rate ( baud )	10M
Maximum common mode voltage ( Volts )	12 to -7
Maximum Driver Output Levels ( Loaded )	+/- 1.5
Maximum Driver Output Levels ( Unloaded )	+/- 6
Drive Load ( Ohms)	60( min )
Driver Output short circuit Resistance ( kohms)	150 to Gnd, 250 to -7 or 12V
Minimum receiver input Resistance ( kohms)	12
Receiver sensitivity	+/- 200mv

#### 5.1.2 儀器通訊接線

RS485 通訊線必須使用雙絞線,其接線方式如下圖所示,所有設備的"D+"端必須接到雙絞線的另一條導線,而所有"D-"端必須接到另外一條導線。通訊線前端與尾端必需各接 120 歐姆電阻,以平衡兩端阻抗。

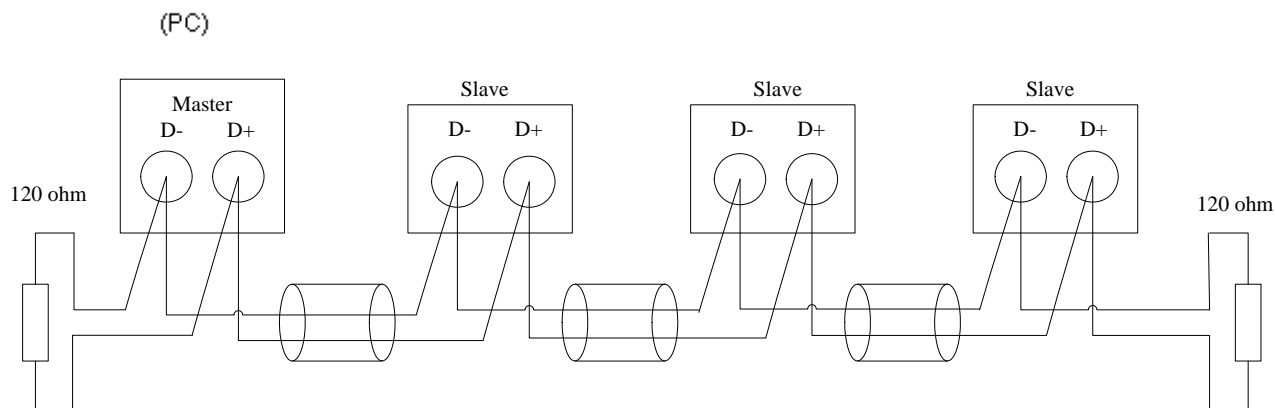

#### 警告：

為避免傳輸遺失,請勿將通訊線連接成“星形”或“環狀”。

## 5.2 Modbus

Modbus 的網路通訊系由“Master”發出一個“請求”到“slave”，“slave”隨時監視並確認網路上“請求”封包的位址,如果是屬於它的,則執行動作並返回一個“回應”給“Master”。

### 5.2.1 Modbus 的格式

#### The Query-Response Cycle

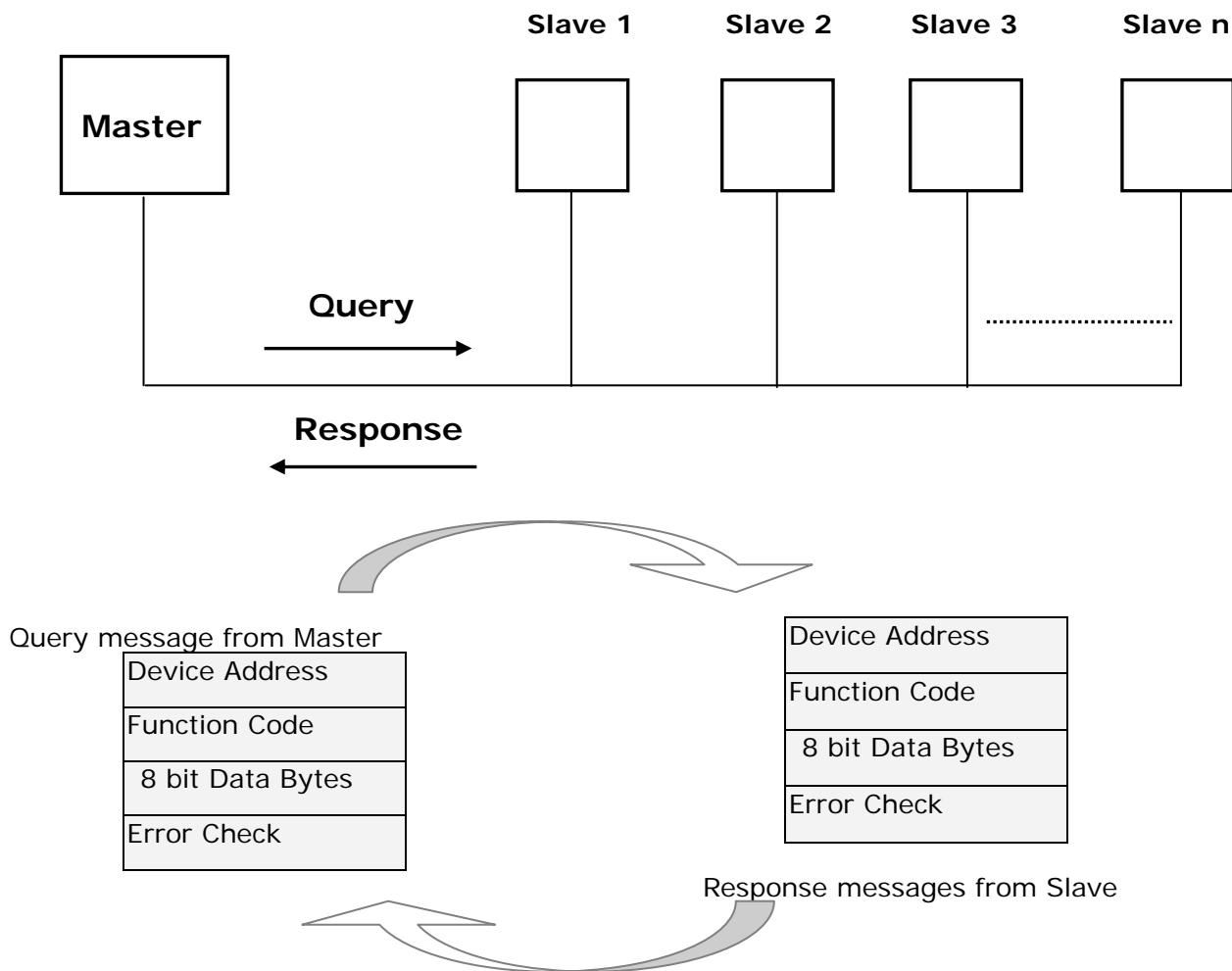

### 5.3 通訊協定

SPM-3 採取 Modbus RTU 模式, Function code 採用 0x03, 0x04 及 0x10, Modbus 通訊協定的 master's "Query" 與 slave's "Response" 格式如下所示。

Query :

Slave Address	Function Code 0x03, 0x04	Start Address (Hi)	Start Address (Lo)	Number of Points (Hi)	Number of Points (Lo)	Error Check (Lo)	Error Check (Hi)
---------------	--------------------------------	--------------------	--------------------	-----------------------	-----------------------	------------------	------------------

Response :

Slave Address	Function Code 0x03, 0x04	Byte Count	Data (Hi)	Data (Lo)	Error Check (Lo)	Error Check (Hi)
---------------	--------------------------------	------------	-----------	-----------	------------------	------------------

Query :

Slave Address	Function Code 0x10	Start Address (Hi)	Start Address (Lo)	Number of Points (Hi)	Number of Points (Lo)	Byte Count	Data (Hi)	Data (Lo)	Error Check (Lo)	Error Check (Hi)
---------------	-----------------------	--------------------	--------------------	-----------------------	-----------------------	------------	-----------	-----------	------------------	------------------

Response :

Slave Address	Function Code 0x10	Start Address (Hi)	Start Address (Lo)	Number of Points (Hi)	Number of Points (Lo)	Error Check (Lo)	Error Check (Hi)
---------------	-----------------------	--------------------	--------------------	-----------------------	-----------------------	------------------	------------------

### 5.4 浮點格式

#### IEEE 754 Format

The bits in an IEEE 754 format have the following significance:

Data Hi Word, Hi Byte	Data Hi Word, Lo Byte	Data Lo Word, Hi Byte	Data Lo Word, Lo Byte
SEEE EEEE	EMMM MMMM	MMMM MMMM	MMMM MMMM

Where:

**S** represents the sign bit where 1 is negative and 0 is positive

**E** is the two's complement exponent with an offset of 127 i.e. an exponent of zero is represented by 127, an exponent of 1 by 128 etc.

**M** is the 23-bit normal mantissa. The highest bit is always 1 and, therefore, is not stored.

For each floating point value requested two MODBUS\_ registers or points (four bytes) must be requested. The received order and significance of these four bytes for the Integral products is shown below:

Data Lo Word, Hi Byte	Data Lo Word, Lo Byte	Data Hi Word, Hi Byte	Data Hi Word, Lo Byte
-----------------------	-----------------------	-----------------------	-----------------------



### 5.5 Modbus RTU Mode

Since Controllers can be setup to communicate on standard Modbus networks using either of two transmission modes : **ASCII** or **RTU**. SPM-3 uses RTU transmission mode only. Users select the RTU mode, along with the serial port communication parameters( baud rate, parity mode, etc ), during configuration of each controller. The mode and serial parameters must be the same for all devices on a Modbus connection.

#### RTU Mode

Coding System	8-bit binary, hexadecimal 0-9, A-F Two hexadecimal character contained in each 8-bit field of the message
Bits per Byte	1 start bit 8 data bits, least significant bit sent first none parity 1/2 stop bit
Error Check Field	Cyclical Redundancy Check(CRC)

### 5.6 Modbus Function Code

The function code of a Modbus message defines the action to be taken by the slave.

Function code use by SPM-3 is described below:

Code	Modbus name	Description
<b>03</b>	Read Holding Registers	Read the content of read/write location ( 4X reference )
<b>04</b>	Read Input Registers	Read the contents of read only location ( 3X reference )
<b>16</b>	Pre-set Multiple Registers	Set the contents of read/write location ( 4X reference )

Note: The maximum registers of Function 03 & Function 04 is 125

## 5.7 SPM-3 通訊參數

### Modbus Module #1 Coil Status : Digital Output

Parameter name	Modbus Register	Comment
Digital Output 1	00000	for function code 01: Read Coil Status & 05 : Force Single Coil
Digital Output 2	00001	for function code 01: Read Coil Status & 05 : Force Single Coil

### Modbus Module #2 Holding Register : Digital Output

Parameter name	Modbus Register		Len	Data Type	Range	Default value	Units	Comment
	Modicom Format	Hex						
Digital Output	44097	0x1000	Word	UInt	bit 0 : Digital Output 1 bit 1 : Digital Output 2	0		
Digital_Output_Reserved	44098	0x1001	Word	UInt				

### Modbus Module #3 Holding Register : Setup Parameter

Parameter name	Modbus Register		Len	Data Type	Range	Default value	Units	Comment
	Modicom Format	Hex						
Comm_485_Address	44099	0x1002	Word	UInt	1-255	15		
Comm_485_BaudRate	44100	0x1003	Word	UInt	0: 4800, 1: 9600, 2: 19200, 3:38400 4: 57600	2	bps	
Comm_485_StopBit	44101	0x1004	Word	UInt	0:1 Stop bit, 1:2 Stop bit	0		
Wiring_Mode	44102	0x1005	Word	UInt	0:1P2W, 1:1P3W, 2:3P3W-2CT, 3:3P3W-3CT, 4:3P4W-Y 5:Auto	5		
PT_Primary	44103- 44104	0x1006- 0x1007	DWord	UInt32	60-600000	110	Volt	
PT_Secondary	44105	0x1008	Word	UInt	1-600	110	Volt	
CT_Primary	44106	0x1009	Word	UInt	1-9999	1	Amp.	
CT_Secondary	44107	0x100A	Word	UInt	1-5	1	Amp.	
Back_Light_Timeout	44108	0x100B	Word	UInt	0-120	1	min	
Brightness	44109	0x100C	Word	UInt	0-4	3		
I1_Flow	44110	0x100D	Word	UInt	0: Positive 1: Negative	0		
I2_Flow	44111	0x100E	Word	UInt	0: Positive 1: Negative	0		
I3_Flow	44112	0x100F	Word	UInt	0: Positive 1: Negative	0		
V1_Up_Limit	44113	0x1010	Word	UInt	0-65535	65535	0.1V	Secondary
V1_Low_Limit	44114	0x1011	Word	UInt	0-65535	0	0.1V	Secondary
V2_Up_Limit	44115	0x1012	Word	UInt	0-65535	65535	0.1V	Secondary
V2_Low_Limit	44116	0x1013	Word	UInt	0-65535	0	0.1V	Secondary
V3_Up_Limit	44117	0x1014	Word	UInt	0-65535	65535	0.1V	Secondary
V3_Low_Limit	44118	0x1015	Word	UInt	0-65535	0	0.1V	Secondary
Demand_mode	44119	0x1016	Word	UInt	0: Block, 1: Rolling	0		
Number_of_Subinterval	44120	0x1017	Word	UInt	1,2,3,4,5,6,10	1		
Subinterval_Length	44121	0x1018	Word	UInt	1,2,3,4,5,6,10,1 2,15,20,30,60	15	min	
Year	44122	0x1019	Word	BCD				
Month	44123	0x101A	Word	BCD				
Date	44124	0x101B	Word	BCD				
Hour	44125	0x101C	Word	BCD				
Min	44126	0x101D	Word	BCD				

Second	44127	0x101E	Word	BCD				
Password	44128	0x101F	Word	UInt	0x0000-0xFFFF	0x0000		
Alarm_Enable	44129	0x1020	Word	UInt	0: OFF, 1: ON	0		
Buzzer_Enable	44130	0x1021	Word	UInt	0: OFF, 1: ON	0		
DO1_Alarm_Item	44131	0x1022	Word	UInt	0: None 1: Any 2: Over Voltage 3: Over Current 4: Over Frequency 5: Over Demand 6: Under Voltage 7: Under Current 8: Under Frequency	0		
DO2_Function	44132	0x1023	Word	UInt	0: Pulse Output 1: Alarm Output	0		
DO2_Alarm_Item	44133	0x1024	Word	UInt	0: None 1: Any 2: Over Voltage 3: Over Current 4: Over Frequency 5: Over Demand 6: Under Voltage 7: Under Current 8: Under Frequency	0		
DO2_Pulse_Item	44134	0x1025	Word	UInt	0: None, 1: kWh 2: kvarh, 3: kVAh	0		
DO2_Pulse_kh	44135	0x1026	Word	UInt	1-6000	10	0.1 kWh	
Over_Voltage_Enable	44136	0x1027	Word	UInt	0: Disable 1: Enable	0		
Over_Current_Enable	44137	0x1028	Word	UInt	0: Disable 1: Enable	0		
Over_Frequency_Enable	44138	0x1029	Word	UInt	0: Disable 1: Enable	0		
Over_Demand_Enable	44139	0x102A	Word	UInt	0: Disable 1: Enable	0		
Under_Voltage_Enable	44140	0x102B	Word	UInt	0: Disable 1: Enable	0		
Under_Current_Enable	44141	0x102C	Word	UInt	0: Disable 1: Enable	0		
Under_Frequency_Enable	44142	0x102D	Word	UInt	0: Disable 1: Enable	0		
Over_Voltage_Set_Point	44143-44144	0x102E-0x102F	DWord	UInt32	0-600000	600000	Volt	
Over_Voltage_Clear_Point	44145-44146	0x1030-0x1031	DWord	UInt32	0-600000	0	Volt	
Over_Current_Set_Point	44147	0x1032	Word	UInt	0-9999	9999	Amp	
Over_Current_Clear_Point	44148	0x1033	Word	UInt	0-9999	0	Amp	
Over_Frequency_Set_Point	44149	0x1034	Word	UInt	450-650	450	0.1Hz	
Over_Frequency_Clear_Point	44150	0x1035	Word	UInt	450-650	650	0.1Hz	
Over_Demand_Set_Point	44151	0x1036	Word	UInt	0-65535	65535	kW	
Over_Demand_Clear_Point	44152	0x1037	Word	UInt	0-65535	0	kW	
Under_Voltage_Set_Point	44153-44154	0x1038-0x1039	DWord	UInt32	0-600000	0	Volt	
Under_Voltage_Clear_Point	44155-44156	0x103A-0x103B	DWord	UInt32	0-600000	600000	Volt	
Under_Current_Set_Point	44157	0x103C	Word	UInt	0-9999	0	Amp	
Under_Current_Clear_Point	44158	0x103D	Word	UInt	0-9999	9999	Amp	
Under_Frequency_Set_Point	44159	0x103E	Word	UInt	450-650	450	0.1Hz	
Under_Frequency_Clear_Point	44160	0x103F	Word	UInt	450-650	650	0.1Hz	
Load_Running_Hour_Iavg	44163	0x1042	Word	UInt	0-9999	0	0.1Amp	

**Modbus Module #4 Holding Register : Clear Function**

Parameter name	Modbus Register		Len	Data Type	Range	Default value	Units	Comment
	Modicom Format	Hex						
Reset_Energy	44609	0x1200	Word	UInt	0x5aa5	0		0x5aa5: clear
Reset_All	44610	0x1201	Word	UInt	0x5aa5	0		0x5aa5: clear
Demand_Reset	44613	0x1204	Word	UInt	0x5aa5	0		0x5aa5: clear
Period_Reset	44614	0x1205	Word	UInt	0x5aa5	0		0x5aa5: clear
Reset_To_Default	44615	0x1206	Word	UInt	0x5aa5	0		0x5aa5: clear
Reset_Voltage_Eligibility	44616	0x1207	Word	UInt	0x5aa5	0		0x5aa5: clear

**Modbus Module #5 Input Register : Realtime Data Voltage, Current, Frequency (Float)**

Parameter name	Modbus Register		Len	Data Type	Range	Units	Comment
	Modicom Format	Hex					
VIn_a	34097-34098	0x1000-0x1001	DWord	Float		Volt	Primary
VIn_b	34099-34100	0x1002-0x1003	DWord	Float		Volt	Primary
VIn_c	34101-34102	0x1004-0x1005	DWord	Float		Volt	Primary
VIn_avg	34103-34104	0x1006-0x1007	DWord	Float		Volt	Primary
VII_ab	34105-34106	0x1008-0x1009	DWord	Float		Volt	Primary
VII_bc	34107-34108	0x100A-0x100B	DWord	Float		Volt	Primary
VII_ca	34109-34110	0x100C-0x100D	DWord	Float		Volt	Primary
VII_avg	34111-34112	0x100E-0x100F	DWord	Float		Volt	Primary
I_a	34113-34114	0x1010-0x1011	DWord	Float		Amp.	Primary
I_b	34115-34116	0x1012-0x1013	DWord	Float		Amp.	Primary
I_c	34117-34118	0x1014-0x1015	DWord	Float		Amp.	Primary
I_avg	34119-34120	0x1016-0x1017	DWord	Float		Amp.	Primary
Frequency	34121-34122	0x1018-0x1019	DWord	Float		Hz	

**Modbus Module #6 Input Register : Realtime Data Power Result (Float)**

Parameter name	Modbus Register		Len	Data Type	Range	Units	Comment
	Modicom Format	Hex					
kW_a	34123-34124	0x101A-0x101B	DWord	Float		kW	Primary
kW_b	34125-34126	0x101C-0x101D	DWord	Float		kW	Primary
kW_c	34127-34128	0x101E-0x101F	DWord	Float		kW	Primary
kW_tot	34129-34130	0x1020-0x1021	DWord	Float		kW	Primary
kvar_a	34131-34132	0x1022-0x1023	DWord	Float		kvar	Primary
kvar_b	34133-34134	0x1024-0x1025	DWord	Float		kvar	Primary
kvar_c	34135-34136	0x1026-0x1027	DWord	Float		kvar	Primary
kvar_tot	34137-34138	0x1028-0x1029	DWord	Float		kvar	Primary
kVA_a	34139-34140	0x102A-0x102B	DWord	Float		kVA	Primary
kVA_b	34141-34142	0x102C-0x102D	DWord	Float		kVA	Primary
kVA_c	34143-34144	0x102E-0x102F	DWord	Float		kVA	Primary
kVA_tot	34145-	0x1030-	DWord	Float		kVA	Primary

	34146	0x1031					
PF	34147-34148	0x1032-0x1033	DWord	Float			

**Modbus Module #7 Input Register : Energy (Float)**

Parameter name	Modbus Register		Len	Data Type	Range	Units	Comment
	Modicom Format	Hex					
kWh	34149-34150	0x1034-0x1035	DWord	Float			
kvarh	34151-34152	0x1036-0x1037	DWord	Float			
kVAh	34153-34154	0x1038-0x1039	DWord	Float			

**Modbus Module #8 Input Register : Realtime data Demand**

Parameter name	Modbus Register		Len	Data Type	Range	Units	Comment
	Modicom Format	Hex					
Demand_kW_Pre_Period	34155-34156	0x103A-0x103B	DWord	Float		kW	Primary
Demand_kW	34157-34158	0x103C-0x103D	DWord	Float		kW	Primary
Demand_Remain_Time	34159	0x103E	Word	UInt		sec	

**Modbus Module #9 Input Register : Unbalance Rate**

Parameter name	Modbus Register		Len	Data Type	Range	Units	Comment
	Modicom Format	Hex					
V_Unbalance_Rate 電壓不平衡率	34160-34161	0x103F-0x1040	DWord	Float		%	
I_Unbalance_Rate 電流不平衡率	34162-34163	0x1041-0x1042	DWord	Float		%	

**Modbus Module #10 Input Register : Voltage Eligibility Rate**

Parameter name	Modbus Register		Len	Data Type	Range	Units	Comment
	Modicom Format	Hex					
Va_Eligibility_Rate Va 電壓合格率	34164-34165	0x1043-0x1044	DWord	Float		%	
Vb_Eligibility_Rate Vb 電壓合格率	34166-34167	0x1045-0x1046	DWord	Float		%	
Vc_Eligibility_Rate Vc 電壓合格率	34168-34169	0x1047-0x1048	DWord	Float		%	
Vavg_Eligibility_Rate 平均電壓合格率	34170-34171	0x1049-0x104A	DWord	Float		%	
Va Eligible Running Hour Va 電壓合格積時	34172-34173	0x104B-0x104C	DWord	UInt32	0-360000000	sec	up to 100000 hr
Vb Eligible Running Hour Vb 電壓合格積時	34174-34175	0x104D-0x104E	DWord	UInt32	0-360000000	sec	up to 100000 hr
Vc Eligible Running Hour Vc 電壓合格積時	34176-34177	0x104F-0x1050	DWord	UInt32	0-360000000	sec	up to 100000 hr
V Eligible total check Running Hours 電壓合格率總判斷積時	34178-34179	0x1051-0x1052	DWord	UInt32	0-360000000	sec	up to 100000 hr

**Modbus Module #12 Input Register : Alarm Flag**

Parameter name	Modbus Register		Len	Data Type	Range	Units	Comment
	Modicom Format	Hex					
Alarm Flag	34184	0x1057	Word	UInt	bit 0: Over Voltage 1: Over Current 2: Over Frequency 3: Over Demand 4: Under Voltage 5: Under Current	bit	0 : Disable 1 : Enable

					6: Under Frequency	
--	--	--	--	--	--------------------	--

**Modbus Module #13 Input Register : THD Data**

Parameter name	Modbus Register		Len	Data Type	Range	Units	Comment
	Modicom Format	Hex					
THD_Va	34185-34186	0x1058-0x1059	DWord	Float		%	
THD_Vb	34187-34188	0x105A-0x105B	DWord	Float		%	
THD_Vc	34189-34190	0x105C-0x105D	DWord	Float		%	
THD_Ia	34191-34192	0x105E-0x105F	DWord	Float		%	
THD_Ib	34193-34194	0x1060-0x1061	DWord	Float		%	
THD_Ic	34195-34196	0x1062-0x1063	DWord	Float		%	

**Modbus Module #14 Input Register : Realtime Data-1 (僅進階版)**

Parameter name	Modbus Register		Len	Data Type	Range	Units	Comment
	Modicom Format	Hex					
I_n	34198-34199	0x1065-0x1066	DWord	Float		Amp.	Primary
PF_a	34200-34201	0x1067-0x1068	DWord	Float			
PF_b	34202-34203	0x1069-0x106A	DWord	Float			
PF_c	34204-34205	0x106B-0x106C	DWord	Float			
PhaseAngle_Va_Va	34206-34207	0x106D-0x106E	DWord	Float			
PhaseAngle_Va_Vb	34208-34209	0x106F-0x1070	DWord	Float			
PhaseAngle_Va_Vc	34210-34211	0x1071-0x1072	DWord	Float			
PhaseAngle_Va_Ia	34212-34213	0x1073-0x1074	DWord	Float			
PhaseAngle_Va_Ib	34214-34215	0x1075-0x1076	DWord	Float			
PhaseAngle_Va_Ic	34216-34217	0x1077-0x1078	DWord	Float			

**Modbus Module #14-1 Input Register : Realtime data Demand-1 (僅進階版)**

Parameter name	Modbus Register		Len	Data Type	Range	Units	Comment
	Modicom Format	Hex					
Demand_Ia_Pre_Period	34218-34219	0x1079-0x107A	DWord	Float		kW	Primary
Demand_Ia	34220-34221	0x107B-0x107C	DWord	Float		kW	Primary
Demand_Ib_Pre_Period	34222-34223	0x107D-0x107E	DWord	Float		kW	Primary
Demand_Ib	34224-34225	0x107F-0x1080	DWord	Float		kW	Primary
Demand_Ic_Pre_Period	34226-34227	0x1081-0x1082	DWord	Float		kW	Primary
Demand_Ic	34228-34229	0x1083-0x1084	DWord	Float		kW	Primary
Demand_kW_Pre_Period	34230-34231	0x1085-0x1086	DWord	Float		kW	Primary
Demand_kW	34232-34233	0x1087-0x1088	DWord	Float		kW	Primary
Demand_kvar_Pre_Period	34234-34235	0x1089-0x108A	DWord	Float		kW	Primary
Demand_kvar	34236-34237	0x108B-0x108C	DWord	Float		kW	Primary
Demand_kVA_Pre_Period	34238-	0x108D-	DWord	Float		kW	Primary

d	34239	0x108E					
Demand_kVA	34240-34241	0x108F-0x1090	DWord	Float		kW	Primary
Demand_Remain_Time	34242	0x1091	Word	UInt		sec	

**Modbus Module #15 Input Register : Max/Min Data**

Parameter name	Modbus Register		Len	Data Type	Range	Units	Comment
	Modicom Format	Hex					
Va_max	34609-34610	0x1200-0x1201	DWord	Float		Volt	
Va_max_Year	34611	0x1202	Word	BCD	00-99		
Va_max_Month	34612	0x1203	Word	BCD	1-12		
Va_max_Date	34613	0x1204	Word	BCD	1-31		
Va_max_Hour	34614	0x1205	Word	BCD	0-23		
Va_max_Min	34615	0x1206	Word	BCD	0-59		
Va_max_Second	34616	0x1207	Word	BCD	0-59		
Va_min	34617-34618	0x1208-0x1209	DWord	Float		Volt	
Va_min_Year	34619	0x120A	Word	BCD	00-99		
Va_min_Month	34620	0x120B	Word	BCD	1-12		
Va_min_Date	34621	0x120C	Word	BCD	1-31		
Va_min_Hour	34622	0x120D	Word	BCD	0-23		
Va_min_Min	34623	0x120E	Word	BCD	0-59		
Va_min_Second	34624	0x120F	Word	BCD	0-59		
Vb_max	34625-34626	0x1210-0x1211	DWord	Float		Volt	
Vb_max_Year	34627	0x1212	Word	BCD	00-99		
Vb_max_Month	34628	0x1213	Word	BCD	1-12		
Vb_max_Date	34629	0x1214	Word	BCD	1-31		
Vb_max_Hour	34630	0x1215	Word	BCD	0-23		
Vb_max_Min	34631	0x1216	Word	BCD	0-59		
Vb_max_Second	34632	0x1217	Word	BCD	0-59		
Vb_min	34633-34634	0x1218-0x1219	DWord	Float		Volt	
Vb_min_Year	34635	0x121A	Word	BCD	00-99		
Vb_min_Month	34636	0x121B	Word	BCD	1-12		
Vb_min_Date	34637	0x121C	Word	BCD	1-31		
Vb_min_Hour	34638	0x121D	Word	BCD	0-23		
Vb_min_Min	34639	0x121E	Word	BCD	0-59		
Vb_min_Second	34640	0x121F	Word	BCD	0-59		
Vc_max	34641-34642	0x1220-0x1221	DWord	Float		Volt	
Vc_max_Year	34643	0x1222	Word	BCD	00-99		
Vc_max_Month	34644	0x1223	Word	BCD	1-12		
Vc_max_Date	34645	0x1224	Word	BCD	1-31		
Vc_max_Hour	34646	0x1225	Word	BCD	0-23		
Vc_max_Min	34647	0x1226	Word	BCD	0-59		
Vc_max_Second	34648	0x1227	Word	BCD	0-59		
Vc_min	34649-34650	0x1228-0x1229	DWord	Float		Volt	
Vc_min_Year	34651	0x122A	Word	BCD	00-99		
Vc_min_Month	34652	0x122B	Word	BCD	1-12		
Vc_min_Date	34653	0x122C	Word	BCD	1-31		
Vc_min_Hour	34654	0x122D	Word	BCD	0-23		
Vc_min_Min	34655	0x122E	Word	BCD	0-59		
Vc_min_Second	34656	0x122F	Word	BCD	0-59		
Vlnavg_max	34657-34658	0x1230-0x1231	DWord	Float		Volt	
Vlnavg_max_Year	34659	0x1232	Word	BCD	00-99		
Vlnavg_max_Month	34660	0x1233	Word	BCD	1-12		
Vlnavg_max_Date	34661	0x1234	Word	BCD	1-31		
Vlnavg_max_Hour	34662	0x1235	Word	BCD	0-23		
Vlnavg_max_Min	34663	0x1236	Word	BCD	0-59		
Vlnavg_max_Second	34664	0x1237	Word	BCD	0-59		
Vlnavg_min	34665-34666	0x1238-0x1239	DWord	Float		Volt	
Vlnavg_min_Year	34667	0x123A	Word	BCD	00-99		
Vlnavg_min_Month	34668	0x123B	Word	BCD	1-12		
Vlnavg_min_Date	34669	0x123C	Word	BCD	1-31		

Vlnavg_min_Hour	34670	0x123D	Word	BCD	0-23		
Vlnavg_min_Min	34671	0x123E	Word	BCD	0-59		
Vlnavg_min_Second	34672	0x123F	Word	BCD	0-59		
Vab_max	34673-34674	0x1240-0x1241	DWord	Float		Volt	
Vab_max_Year	34675	0x1242	Word	BCD	00-99		
Vab_max_Month	34676	0x1243	Word	BCD	1-12		
Vab_max_Date	34677	0x1244	Word	BCD	1-31		
Vab_max_Hour	34678	0x1245	Word	BCD	0-23		
Vab_max_Min	34679	0x1246	Word	BCD	0-59		
Vab_max_Second	34680	0x1247	Word	BCD	0-59		
Vab_min	34681-34682	0x1248-0x1249	DWord	Float		Volt	
Vab_min_Year	34683	0x124A	Word	BCD	00-99		
Vab_min_Month	34684	0x124B	Word	BCD	1-12		
Vab_min_Date	34685	0x124C	Word	BCD	1-31		
Vab_min_Hour	34686	0x124D	Word	BCD	0-23		
Vab_min_Min	34687	0x124E	Word	BCD	0-59		
Vab_min_Second	34688	0x124F	Word	BCD	0-59		
Vbc_max	34689-34690	0x1250-0x1251	DWord	Float		Volt	
V.bc_max_Year	34691	0x1252	Word	BCD	00-99		
Vbc_max_Month	34692	0x1253	Word	BCD	1-12		
Vbc_max_Date	34693	0x1254	Word	BCD	1-31		
Vbc_max_Hour	34694	0x1255	Word	BCD	0-23		
Vbc_max_Min	34695	0x1256	Word	BCD	0-59		
Vbc_max_Second	34696	0x1257	Word	BCD	0-59		
Vbc_min	34697-34698	0x1258-0x1259	DWord	Float		Volt	
Vbc_min_Year	34699	0x125A	Word	BCD	00-99		
Vbc_min_Month	34700	0x125B	Word	BCD	1-12		
Vbc_min_Date	34701	0x125C	Word	BCD	1-31		
Vbc_min_Hour	34702	0x125D	Word	BCD	0-23		
Vbc_min_Min	34703	0x125E	Word	BCD	0-59		
Vbc_min_Second	34704	0x125F	Word	BCD	0-59		
Vca_max	34705-34706	0x1260-0x1261	DWord	Float		Volt	
Vca_max_Year	34707	0x1262	Word	BCD	00-99		
Vca_max_Month	34708	0x1263	Word	BCD	1-12		
Vca_max_Date	34709	0x1264	Word	BCD	1-31		
Vca_max_Hour	34710	0x1265	Word	BCD	0-23		
Vca_max_Min	34711	0x1266	Word	BCD	0-59		
Vca_max_Second	34712	0x1267	Word	BCD	0-59		
Vca_min	34713-34714	0x1268-0x1269	DWord	Float		Volt	
Vca_min_Year	34715	0x126A	Word	BCD	00-99		
Vca_min_Month	34716	0x126B	Word	BCD	1-12		
Vca_min_Date	34717	0x126C	Word	BCD	1-31		
Vca_min_Hour	34718	0x126D	Word	BCD	0-23		
Vca_min_Min	34719	0x126E	Word	BCD	0-59		
Vca_min_Second	34720	0x126F	Word	BCD	0-59		
Vllavg_max	34721-34722	0x1270-0x1271	DWord	Float		Volt	
Vllavg_max_Year	34723	0x1272	Word	BCD	00-99		
Vllavg_max_Month	34724	0x1273	Word	BCD	1-12		
Vllavg_max_Date	34725	0x1274	Word	BCD	1-31		
Vllavg_max_Hour	34726	0x1275	Word	BCD	0-23		
Vllavg_max_Min	34727	0x1276	Word	BCD	0-59		
Vllavg_max_Second	34728	0x1277	Word	BCD	0-59		
Vllavg_min	34729-34730	0x1278-0x1279	DWord	Float		Volt	
Vllavg_min_Year	34731	0x127A	Word	BCD	00-99		
Vllavg_min_Month	34732	0x127B	Word	BCD	1-12		
Vllavg_min_Date	34733	0x127C	Word	BCD	1-31		
Vllavg_min_Hour	34734	0x127D	Word	BCD	0-23		
Vllavg_min_Min	34735	0x127E	Word	BCD	0-59		
Vllavg_min_Second	34736	0x127F	Word	BCD	0-59		
Ia_max	34737-34738	0x1280-0x1281	DWord	Float		Amp	



la_max_Year	34739	0x1282	Word	BCD	00-99		
la_max_Month	34740	0x1283	Word	BCD	1-12		
la_max_Date	34741	0x1284	Word	BCD	1-31		
la_max_Hour	34742	0x1285	Word	BCD	0-23		
la_max_Min	34743	0x1286	Word	BCD	0-59		
la_max_Second	34744	0x1287	Word	BCD	0-59		
la_min	34745-34746	0x1288-0x1289	DWord	Float		Amp	
la_min_Year	34747	0x128A	Word	BCD	00-99		
la_min_Month	34748	0x128B	Word	BCD	1-12		
la_min_Date	34749	0x128C	Word	BCD	1-31		
la_min_Hour	34750	0x128D	Word	BCD	0-23		
la_min_Min	34751	0x128E	Word	BCD	0-59		
la_min_Second	34752	0x128F	Word	BCD	0-59		
lb_max	34753-34754	0x1290-0x1291	DWord	Float		Amp	
lb_max_Year	34755	0x1292	Word	BCD	00-99		
lb_max_Month	34756	0x1293	Word	BCD	1-12		
lb_max_Date	34757	0x1294	Word	BCD	1-31		
lb_max_Hour	34758	0x1295	Word	BCD	0-23		
lb_max_Min	34759	0x1296	Word	BCD	0-59		
lb_max_Second	34760	0x1297	Word	BCD	0-59		
lb_min	34761-34762	0x1298-0x1299	DWord	Float		Amp	
lb_min_Year	34763	0x129A	Word	BCD	00-99		
lb_min_Month	34764	0x129B	Word	BCD	1-12		
lb_min_Date	34765	0x129C	Word	BCD	1-31		
lb_min_Hour	34766	0x129D	Word	BCD	0-23		
lb_min_Min	34767	0x129E	Word	BCD	0-59		
lb_min_Second	34768	0x129F	Word	BCD	0-59		
lc_max	34769-34770	0x12A0-0x12A1	DWord	Float		Amp	
lc_max_Year	34771	0x12A2	Word	BCD	00-99		
lc_max_Month	34772	0x12A3	Word	BCD	1-12		
lc_max_Date	34773	0x12A4	Word	BCD	1-31		
lc_max_Hour	34774	0x12A5	Word	BCD	0-23		
lc_max_Min	34775	0x12A6	Word	BCD	0-59		
lc_max_Second	34776	0x12A7	Word	BCD	0-59		
lc_min	34777-34778	0x12A8-0x12A9	DWord	Float		Amp	
lc_min_Year	34779	0x12AA	Word	BCD	00-99		
lc_min_Month	34780	0x12AB	Word	BCD	1-12		
lc_min_Date	34781	0x12AC	Word	BCD	1-31		
lc_min_Hour	34782	0x12AD	Word	BCD	0-23		
lc_min_Min	34783	0x12AE	Word	BCD	0-59		
lc_min_Second	34784	0x12AF	Word	BCD	0-59		
lavg_max	34785-34786	0x12B0-0x12B1	DWord	Float		Amp	
lavg_max_Year	34787	0x12B2	Word	BCD	00-99		
lavg_max_Month	34788	0x12B3	Word	BCD	1-12		
lavg_max_Date	34789	0x12B4	Word	BCD	1-31		
lavg_max_Hour	34790	0x12B5	Word	BCD	0-23		
lavg_max_Min	34791	0x12B6	Word	BCD	0-59		
lavg_max_Second	34792	0x12B7	Word	BCD	0-59		
lavg_min	34793-34794	0x12B8-0x12B9	DWord	Float		Amp	
lavg_min_Year	34795	0x12BA	Word	BCD	00-99		
lavg_min_Month	34796	0x12BB	Word	BCD	1-12		
lavg_min_Date	34797	0x12BC	Word	BCD	1-31		
lavg_min_Hour	34798	0x12BD	Word	BCD	0-23		
lavg_min_Min	34799	0x12BE	Word	BCD	0-59		
lavg_min_Second	34800	0x12BF	Word	BCD	0-59		
kWa_max	34801-34802	0x12C0-0x12C1	DWord	Float			
kWa_max_Year	34803	0x12C2	Word	BCD	00-99		
kWa_max_Month	34804	0x12C3	Word	BCD	1-12		
kWa_max_Date	34805	0x12C4	Word	BCD	1-31		
kWa_max_Hour	34806	0x12C5	Word	BCD	0-23		
kWa_max_Min	34807	0x12C6	Word	BCD	0-59		
kWa_max_Second	34808	0x12C7	Word	BCD	0-59		

kWa_min	34809-34810	0x12C8-0x12C9	DWord	Float		
kWa_min_Year	34811	0x12CA	Word	BCD	00-99	
kWa_min_Month	34812	0x12CB	Word	BCD	1-12	
kWa_min_Date	34813	0x12CC	Word	BCD	1-31	
kWa_min_Hour	34814	0x12CD	Word	BCD	0-23	
kWa_min_Min	34815	0x12CE	Word	BCD	0-59	
kWa_min_Second	34816	0x12CF	Word	BCD	0-59	
kWb_max	34817-34818	0x12D0-0x12D1	DWord	Float		
kWb_max_Year	34819	0x12D2	Word	BCD	00-99	
kWb_max_Month	34820	0x12D3	Word	BCD	1-12	
kWb_max_Date	34821	0x12D4	Word	BCD	1-31	
kWb_max_Hour	34822	0x12D5	Word	BCD	0-23	
kWb_max_Min	34823	0x12D6	Word	BCD	0-59	
kWb_max_Second	34824	0x12D7	Word	BCD	0-59	
kWb_min	34825-34826	0x12D8-0x12D9	DWord	Float		
kWb_min_Year	34827	0x12DA	Word	BCD	00-99	
kWb_min_Month	34828	0x12DB	Word	BCD	1-12	
kWb_min_Date	34829	0x12DC	Word	BCD	1-31	
kWb_min_Hour	34830	0x12DD	Word	BCD	0-23	
kWb_min_Min	34831	0x12DE	Word	BCD	0-59	
kWb_min_Second	34832	0x12DF	Word	BCD	0-59	
kWc_max	34833-34834	0x12E0-0x12E1	DWord	Float		
kWc_max_Year	34835	0x12E2	Word	BCD	00-99	
kWc_max_Month	34836	0x12E3	Word	BCD	1-12	
kWc_max_Date	34837	0x12E4	Word	BCD	1-31	
kWc_max_Hour	34838	0x12E5	Word	BCD	0-23	
kWc_max_Min	34839	0x12E6	Word	BCD	0-59	
kWc_max_Second	34840	0x12E7	Word	BCD	0-59	
kWc_min	34841-34842	0x12E8-0x12E9	DWord	Float		
kWc_min_Year	34843	0x12EA	Word	BCD	00-99	
kWc_min_Month	34844	0x12EB	Word	BCD	1-12	
kWc_min_Date	34845	0x12EC	Word	BCD	1-31	
kWc_min_Hour	34846	0x12ED	Word	BCD	0-23	
kWc_min_Min	34847	0x12EE	Word	BCD	0-59	
kWc_min_Second	34848	0x12EF	Word	BCD	0-59	
kWtot_max	34849-34850	0x12F0-0x12F1	DWord	Float		
kWtot_max_Year	34851	0x12F2	Word	BCD	00-99	
kWtot_max_Month	34852	0x12F3	Word	BCD	1-12	
kWtot_max_Date	34853	0x12F4	Word	BCD	1-31	
kWtot_max_Hour	34854	0x12F5	Word	BCD	0-23	
kWtot_max_Min	34855	0x12F6	Word	BCD	0-59	
kWtot_max_Second	34856	0x12F7	Word	BCD	0-59	
kWtot_min	34857-34858	0x12F8-0x12F9	DWord	Float		
kWtot_min_Year	34859	0x12FA	Word	BCD	00-99	
kWtot_min_Month	34860	0x12FB	Word	BCD	1-12	
kWtot_min_Date	34861	0x12FC	Word	BCD	1-31	
kWtot_min_Hour	34862	0x12FD	Word	BCD	0-23	
kWtot_min_Min	34863	0x12FE	Word	BCD	0-59	
kWtot_min_Second	34864	0x12FF	Word	BCD	0-59	
kvara_max	34865-34866	0x1300-0x1301	DWord	Float		
kvara_max_Year	34867	0x1302	Word	BCD	00-99	
kvara_max_Month	34868	0x1303	Word	BCD	1-12	
kvara_max_Date	34869	0x1304	Word	BCD	1-31	
kvara_max_Hour	34870	0x1305	Word	BCD	0-23	
kvara_max_Min	34871	0x1306	Word	BCD	0-59	
kvara_max_Second	34872	0x1307	Word	BCD	0-59	
kvara_min	34873-34874	0x1308-0x1309	DWord	Float		
kvara_min_Year	34875	0x130A	Word	BCD	00-99	
kvara_min_Month	34876	0x130B	Word	BCD	1-12	
kvara_min_Date	34877	0x130C	Word	BCD	1-31	
kvara_min_Hour	34878	0x130D	Word	BCD	0-23	

kvara_min_Min	34879	0x130E	Word	BCD	0-59		
kvara_min_Second	34880	0x130F	Word	BCD	0-59		
kvarb_max	34881-34882	0x1310-0x1311	DWord	Float			
kvarb_max_Year	34883	0x1312	Word	BCD	00-99		
kvarb_max_Month	34884	0x1313	Word	BCD	1-12		
kvarb_max_Date	34885	0x1314	Word	BCD	1-31		
kvarb_max_Hour	34886	0x1315	Word	BCD	0-23		
kvarb_max_Min	34887	0x1316	Word	BCD	0-59		
kvarb_max_Second	34888	0x1317	Word	BCD	0-59		
kvarb_min	34889-34890	0x1318-0x1319	DWord	Float			
kvarb_min_Year	34891	0x131A	Word	BCD	00-99		
kvarb_min_Month	34892	0x131B	Word	BCD	1-12		
kvarb_min_Date	34893	0x131C	Word	BCD	1-31		
kvarb_min_Hour	34894	0x131D	Word	BCD	0-23		
kvarb_min_Min	34895	0x131E	Word	BCD	0-59		
kvarb_min_Second	34896	0x131F	Word	BCD	0-59		
kvarc_max	34897-34898	0x1320-0x1321	DWord	Float			
kvarc_max_Year	34899	0x1322	Word	BCD	00-99		
kvarc_max_Month	34900	0x1323	Word	BCD	1-12		
kvarc_max_Date	34901	0x1324	Word	BCD	1-31		
kvarc_max_Hour	34902	0x1325	Word	BCD	0-23		
kvarc_max_Min	34903	0x1326	Word	BCD	0-59		
kvarc_max_Second	34904	0x1327	Word	BCD	0-59		
kvarc_min	34905-34906	0x1328-0x1329	DWord	Float			
kvarc_min_Year	34907	0x132A	Word	BCD	00-99		
kvarc_min_Month	34908	0x132B	Word	BCD	1-12		
kvarc_min_Date	34909	0x132C	Word	BCD	1-31		
kvarc_min_Hour	34910	0x132D	Word	BCD	0-23		
kvarc_min_Min	34911	0x132E	Word	BCD	0-59		
kvara_min_Second	34912	0x132F	Word	BCD	0-59		
kvartot_max	34913-34914	0x1330-0x1331	DWord	Float			
kvartot_max_Year	34915	0x1332	Word	BCD	00-99		
kvartot_max_Month	34916	0x1333	Word	BCD	1-12		
kvartot_max_Date	34917	0x1334	Word	BCD	1-31		
kvartot_max_Hour	34918	0x1335	Word	BCD	0-23		
kvartot_max_Min	34919	0x1336	Word	BCD	0-59		
kvartot_max_Second	34920	0x1337	Word	BCD	0-59		
kvartot_min	34921-34922	0x1338-0x1339	DWord	Float			
kvartot_min_Year	34923	0x133A	Word	BCD	00-99		
kvartot_min_Month	34924	0x133B	Word	BCD	1-12		
kvartot_min_Date	34925	0x133C	Word	BCD	1-31		
kvartot_min_Hour	34926	0x133D	Word	BCD	0-23		
kvartot_min_Min	34927	0x133E	Word	BCD	0-59		
kvartot_min_Second	34928	0x133F	Word	BCD	0-59		
kVAa_max	34929-34930	0x1340-0x1341	DWord	Float			
kVAa_max_Year	34931	0x1342	Word	BCD	00-99		
kVAa_max_Month	34932	0x1343	Word	BCD	1-12		
kVAa_max_Date	34933	0x1344	Word	BCD	1-31		
kVAa_max_Hour	34934	0x1345	Word	BCD	0-23		
kVAa_max_Min	34935	0x1346	Word	BCD	0-59		
kVAa_max_Second	34936	0x1347	Word	BCD	0-59		
kVAa_min	34937-34938	0x1348-0x1349	DWord	Float			
kVAa_min_Year	34939	0x134A	Word	BCD	00-99		
kVAa_min_Month	34940	0x134B	Word	BCD	1-12		
kVAa_min_Date	34941	0x134C	Word	BCD	1-31		
kVAa_min_Hour	34942	0x134D	Word	BCD	0-23		
kVAa_min_Min	34943	0x134E	Word	BCD	0-59		
kVAa_min_Second	34944	0x134F	Word	BCD	0-59		
kVAb_max	34945-34946	0x1350-0x1351	DWord	Float			
kVAb_max_Year	34947	0x1352	Word	BCD	00-99		

kVAb_max_Month	34948	0x1353	Word	BCD	1-12		
kVAb_max_Date	34949	0x1354	Word	BCD	1-31		
kVAb_max_Hour	34950	0x1355	Word	BCD	0-23		
kVAb_max_Min	34951	0x1356	Word	BCD	0-59		
kVAb_max_Second	34952	0x1357	Word	BCD	0-59		
kVAb_min	34953-34954	0x1358-0x1359	DWord	Float			
kVAb_min_Year	34955	0x135A	Word	BCD	00-99		
kVAb_min_Month	34956	0x135B	Word	BCD	1-12		
kVAb_min_Date	34957	0x135C	Word	BCD	1-31		
kVAb_min_Hour	34958	0x135D	Word	BCD	0-23		
kVAb_min_Min	34959	0x135E	Word	BCD	0-59		
kVAb_min_Second	34960	0x135F	Word	BCD	0-59		
kVAc_max	34961-34962	0x1360-0x1361	DWord	Float			
kVAc_max_Year	34963	0x1362	Word	BCD	00-99		
kVAc_max_Month	34964	0x1363	Word	BCD	1-12		
kVAc_max_Date	34965	0x1364	Word	BCD	1-31		
kVAc_max_Hour	34966	0x1365	Word	BCD	0-23		
kVAc_max_Min	34967	0x1366	Word	BCD	0-59		
kVAc_max_Second	34968	0x1367	Word	BCD	0-59		
kVAc_min	34969-34970	0x1368-0x1369	DWord	Float			
kVAc_min_Year	34971	0x136A	Word	BCD	00-99		
kVAc_min_Month	34972	0x136B	Word	BCD	1-12		
kVAc_min_Date	34973	0x136C	Word	BCD	1-31		
kVAc_min_Hour	34974	0x136D	Word	BCD	0-23		
kVAc_min_Min	34975	0x136E	Word	BCD	0-59		
kVAc_min_Second	34976	0x136F	Word	BCD	0-59		
kVAtot_max	34977-34978	0x1370-0x1371	DWord	Float			
kVAtot_max_Year	34979	0x1372	Word	BCD	00-99		
kVAtot_max_Month	34980	0x1373	Word	BCD	1-12		
kVAtot_max_Date	34981	0x1374	Word	BCD	1-31		
kVAtot_max_Hour	34982	0x1375	Word	BCD	0-23		
kVAtot_max_Min	34983	0x1376	Word	BCD	0-59		
kVAtot_max_Second	34984	0x1377	Word	BCD	0-59		
kVAtot_min	34985-34986	0x1378-0x1379	DWord	Float			
kVAtot_min_Year	34987	0x137A	Word	BCD	00-99		
kVAtot_min_Month	34988	0x137B	Word	BCD	1-12		
kVAtot_min_Date	34989	0x137C	Word	BCD	1-31		
kVAtot_min_Hour	34990	0x137D	Word	BCD	0-23		
kVAtot_min_Min	34991	0x137E	Word	BCD	0-59		
kVAtot_min_Second	34992	0x137F	Word	BCD	0-59		
Frequency_max	34993-34994	0x1380-0x1381	DWord	Float			
Frequency_max_Year	34995	0x1382	Word	BCD	00-99		
Frequency_max_Month	34996	0x1383	Word	BCD	1-12		
Frequency_max_Date	34997	0x1384	Word	BCD	1-31		
Frequency_max_Hour	34998	0x1385	Word	BCD	0-23		
Frequency_max_Min	34999	0x1386	Word	BCD	0-59		
Frequency_max_Second	35000	0x1387	Word	BCD	0-59		
Frequency_min	35001-35002	0x1388-0x1389	DWord	Float			
Frequency_min_Year	35003	0x138A	Word	BCD	00-99		
Frequency_min_Month	35004	0x138B	Word	BCD	1-12		
Frequency_min_Date	35005	0x138C	Word	BCD	1-31		
Frequency_min_Hour	35006	0x138D	Word	BCD	0-23		
Frequency_min_Min	35007	0x138E	Word	BCD	0-59		
Frequency_min_Second	35008	0x138F	Word	BCD	0-59		
PF_min	35009-35010	0x1390-0x1391	DWord	Float			
PF_min_Year	35011	0x1392	Word	BCD	00-99		
PF_min_Month	35012	0x1393	Word	BCD	1-12		
PF_min_Date	35013	0x1394	Word	BCD	1-31		
PF_min_Hour	35014	0x1395	Word	BCD	0-23		
PF_min_Min	35015	0x1396	Word	BCD	0-59		

PF_min_Second	35016	0x1397	Word	BCD	0-59		
Demand_kW_max	35017-35018	0x1398-0x1399	DWord	Float			
Demand_kW_max_Year	35019	0x139A	Word	BCD	00-99		
Demand_kW_max_Month	35020	0x139B	Word	BCD	1-12		
Demand_kW_max_Date	35021	0x139C	Word	BCD	1-31		
Demand_kW_max_Hour	35022	0x139D	Word	BCD	0-23		
Demand_kW_max_Min	35023	0x139E	Word	BCD	0-59		
Demand_kW_max_Second	35024	0x139F	Word	BCD	0-59		
V_Unbalance_max	35025-35026	0x13A0-0x13A1	DWord	Float			
V_Unbalance_max_Year	35027	0x13A2	Word	BCD	00-99		
V_Unbalance_max_Month	35028	0x13A3	Word	BCD	1-12		
V_Unbalance_max_Date	35029	0x13A4	Word	BCD	1-31		
V_Unbalance_max_Hour	35030	0x13A5	Word	BCD	0-23		
V_Unbalance_max_Min	35031	0x13A6	Word	BCD	0-59		
V_Unbalance_max_Second	35032	0x13A7	Word	BCD	0-59		
V_Unbalance_min	35033-35034	0x13A8-0x13A9	DWord	Float			
V_Unbalance_min_Year	35035	0x13AA	Word	BCD	00-99		
V_Unbalance_min_Month	35036	0x13AB	Word	BCD	1-12		
V_Unbalance_min_Date	35037	0x13AC	Word	BCD	1-31		
V_Unbalance_min_Hour	35038	0x13AD	Word	BCD	0-23		
V_Unbalance_min_Min	35039	0x13AE	Word	BCD	0-59		
V_Unbalance_min_Second	35040	0x13AF	Word	BCD	0-59		
I_Unbalance_max	35041-35042	0x13B0-0x13B1	DWord	Float			
I_Unbalance_max_Year	35043	0x13B2	Word	BCD	00-99		
I_Unbalance_max_Month	35044	0x13B3	Word	BCD	1-12		
I_Unbalance_max_Date	35045	0x13B4	Word	BCD	1-31		
I_Unbalance_max_Hour	35046	0x13B5	Word	BCD	0-23		
I_Unbalance_max_Min	35047	0x13B6	Word	BCD	0-59		
I_Unbalance_max_Second	35048	0x13B7	Word	BCD	0-59		
I_Unbalance_min	35049-35050	0x13B8-0x13B9	DWord	Float			
I_Unbalance_min_Year	35051	0x13BA	Word	BCD	00-99		
I_Unbalance_min_Month	35052	0x13BB	Word	BCD	1-12		
I_Unbalance_min_Date	35053	0x13BC	Word	BCD	1-31		
I_Unbalance_min_Hour	35054	0x13BD	Word	BCD	0-23		
I_Unbalance_min_Min	35055	0x13BE	Word	BCD	0-59		
I_Unbalance_min_Second	35056	0x13BF	Word	BCD	0-59		
VaTHD_max	35057-35058	0x13C0-0x13C1	DWord	Float			
VaTHD_max_Year	35059	0x13C2	Word	BCD	00-99		
VaTHD_max_Month	35060	0x13C3	Word	BCD	1-12		
VaTHD_max_Date	35061	0x13C4	Word	BCD	1-31		
VaTHD_max_Hour	35062	0x13C5	Word	BCD	0-23		
VaTHD_max_Min	35063	0x13C6	Word	BCD	0-59		
VaTHD_max_Second	35064	0x13C7	Word	BCD	0-59		
VbTHD_max	35065-35066	0x13C8-0x13C9	DWord	Float			
VbTHD_max_Year	35067	0x13CA	Word	BCD	00-99		
VbTHD_max_Month	35068	0x13CB	Word	BCD	1-12		
VbTHD_max_Date	35069	0x13CC	Word	BCD	1-31		
VbTHD_max_Hour	35070	0x13CD	Word	BCD	0-23		
VbTHD_max_Min	35071	0x13CE	Word	BCD	0-59		
VbTHD_max_Second	35072	0x13CF	Word	BCD	0-59		
VcTHD_max	35073-35074	0x13D0-0x13D1	DWord	Float			
VcTHD_max_Year	35075	0x13D2	Word	BCD	00-99		
VcTHD_max_Month	35076	0x13D3	Word	BCD	1-12		
VcTHD_max_Date	35077	0x13D4	Word	BCD	1-31		
VcTHD_max_Hour	35078	0x13D5	Word	BCD	0-23		
VcTHD_max_Min	35079	0x13D6	Word	BCD	0-59		
VcTHD_max_Second	35080	0x13D7	Word	BCD	0-59		
IaTHD_max	35081-35082	0x13D8-0x13D9	DWord	Float			

IaTHD_max_Year	35083	0x13DA	Word	BCD	00-99		
IaTHD_max_Month	35084	0x13DB	Word	BCD	1-12		
IaTHD_max_Date	35085	0x13DC	Word	BCD	1-31		
IaTHD_max_Hour	35086	0x13DD	Word	BCD	0-23		
IaTHD_max_Min	35087	0x13DE	Word	BCD	0-59		
IaTHD_max_Second	35088	0x13DF	Word	BCD	0-59		
IbTHD_max	35089-35090	0x139E0-0x13E1	DWord	Float			
IbTHD_max_Year	35091	0x13E2	Word	BCD	00-99		
IbTHD_max_Month	35092	0x13E3	Word	BCD	1-12		
IbTHD_max_Date	35093	0x13E4	Word	BCD	1-31		
IbTHD_max_Hour	35094	0x13E5	Word	BCD	0-23		
IbTHD_max_Min	35095	0x13E6	Word	BCD	0-59		
IbTHD_max_Second	35096	0x13E7	Word	BCD	0-59		
IcTHD_max	35097-35098	0x13E8-0x13E9	DWord	Float			
IcTHD_max_Year	35099	0x13EA	Word	BCD	00-99		
IcTHD_max_Month	35100	0x13EB	Word	BCD	1-12		
IcTHD_max_Date	35101	0x13EC	Word	BCD	1-31		
IcTHD_max_Hour	35102	0x13ED	Word	BCD	0-23		
IcTHD_max_Min	35103	0x13EE	Word	BCD	0-59		
IcTHD_max_Second	35104	0x13EF	Word	BCD	0-59		

**Modbus Module #15-1 Input Register : Max/Min Data (僅進階版)**

Parameter name	Modbus Register		Len	Data Type	Range	Units	Comment
	Modicom Format	Hex					
Demand_Ia_max	35105-35106	0x13F0-0x13F1	DWord	Float			
Demand_Ia_max_Year	35107	0x13F2	Word	BCD	00-99		
Demand_Ia_max_Month	35108	0x13F3	Word	BCD	1-12		
Demand_Ia_max_Date	35109	0x13F4	Word	BCD	1-31		
Demand_Ia_max_Hour	35110	0x13F5	Word	BCD	0-23		
Demand_Ia_max_Min	35111	0x13F6	Word	BCD	0-59		
Demand_Ia_max_Second	35112	0x13F7	Word	BCD	0-59		
Demand_Ia_max	35113-35114	0x13F8-0x13F9	DWord	Float			
Demand_Ib_max_Year	35115	0x13FA	Word	BCD	00-99		
Demand_Ib_max_Month	35116	0x13FB	Word	BCD	1-12		
Demand_Ib_max_Date	35117	0x13FC	Word	BCD	1-31		
Demand_Ib_max_Hour	35118	0x13FD	Word	BCD	0-23		
Demand_Ib_max_Min	35119	0x13FE	Word	BCD	0-59		
Demand_Ib_max_Second	35120	0x13FF	Word	BCD	0-59		
Demand_Ic_max	35121-35122	0x1400-0x1401	DWord	Float			
Demand_Ic_max_Year	35123	0x1402	Word	BCD	00-99		
Demand_Ic_max_Month	35124	0x1403	Word	BCD	1-12		
Demand_Ic_max_Date	35125	0x1404	Word	BCD	1-31		
Demand_Ic_max_Hour	35126	0x1405	Word	BCD	0-23		
Demand_Ic_max_Min	35127	0x1406	Word	BCD	0-59		
Demand_Ic_max_Second	35128	0x1407	Word	BCD	0-59		
Demand_kvar_max	35129-35130	0x1408-0x1409	DWord	Float			
Demand_kvar_max_Year	35131	0x140A	Word	BCD	00-99		
Demand_kvar_max_Month	35132	0x140B	Word	BCD	1-12		
Demand_kvar_max_Date	35133	0x140C	Word	BCD	1-31		
Demand_kvar_max_Hour	35134	0x140D	Word	BCD	0-23		
Demand_kvar_max_Min	35135	0x140E	Word	BCD	0-59		
Demand_kvar_max_Second	35136	0x140F	Word	BCD	0-59		
Demand_kVA_max	35137-35138	0x1410-0x1411	DWord	Float			
Demand_kVA_max_Year	35139	0x1412	Word	BCD	00-99		
Demand_kVA_max_Month	35140	0x1413	Word	BCD	1-12		
Demand_kVA_max_Date	35141	0x1414	Word	BCD	1-31		
Demand_kVA_max_Hour	35142	0x1415	Word	BCD	0-23		
Demand_kVA_max_Min	35143	0x1416	Word	BCD	0-59		
Demand_kVA_max_Second	35144	0x1417	Word	BCD	0-59		

**Modbus Module #16 Input Register : RealtimeData**

Parameter name	Modbus Register		Len	Data Type	Range	Units	Comment
	Modicom Format	Hex					
VIn_a	31025-31026	0x0400-0x0401	DWord	Float			
VIn_b	31027-31028	0x0402-0x0403	DWord	Float			
VIn_c	31029-31030	0x0404-0x0405	DWord	Float			
VIn_avg	31031-31032	0x0406-0x0407	DWord	Float			
VII_ab	31033-31034	0x0408-0x0409	DWord	Float			
VII_bc	31035-31036	0x040A-0x040B	DWord	Float			
VII_ca	31037-31038	0x040C-0x040D	DWord	Float			
VII_avg	31039-31040	0x040E-0x040F	DWord	Float			
I_a	31041-31042	0x0400-0x0401	DWord	Float			
I_b	31043-31044	0x0412-0x0413	DWord	Float			
I_c	31045-31046	0x0414-0x0415	DWord	Float			
I_avg	31047-31048	0x0416-0x0417	DWord	Float			
Reserved	31049-31050	0x0418-0x0419	DWord	Float	0		
Freq	31051-31052	0x041A-0x041B	DWord	Float			
kW_a	31053-31054	0x041C-0x041D	DWord	Float			
kW_b	31055-31056	0x041E-0x041F	DWord	Float			
kW_c	31057-31058	0x0420-0x0421	DWord	Float			
kW_total	31059-31060	0x0422-0x0423	DWord	Float			
kvar_a	31061-31062	0x0424-0x0425	DWord	Float			
kvar_b	31063-31064	0x0426-0x0427	DWord	Float			
kvar_c	31065-31066	0x0428-0x0429	DWord	Float			
kvar_total	31067-31068	0x042A-0x042B	DWord	Float			
kVA_a	31069-31070	0x042C-0x042D	DWord	Float			
kVA_b	31071-31072	0x042E-0x042F	DWord	Float			
kVA_c	31073-31074	0x0430-0x0431	DWord	Float			
kVA_total	31075-31076	0x0432-0x0433	DWord	Float			
Reserved	31077-31078	0x0434-0x0435	DWord	Float	0		
Reserved	31079-31080	0x0436-0x0437	DWord	Float	0		
Reserved	31081-31082	0x0438-0x0439	DWord	Float	0		
PF_signed_avg	31083-31084	0x043A-0x043B	DWord	Float			
Reserved	31085-31086	0x043C-0x043D	DWord	Float	0		
Reserved	31087-31088	0x043E-0x043F	DWord	Float	0		
Reserved	31089-31090	0x0440-0x0441	DWord	Float	0		

Reserved	31091-31092	0x0442-0x0443	DWord	Float	0		
Reserved	31093-31094	0x0444-0x0445	DWord	Float	0		
Reserved	31095-31096	0x0446-0x0447	DWord	Float	0		

**Modbus Module #18 Input Register : Energy Data**

Parameter name	Modbus Register		Len	Data Type	Range	Units	Comment
	Modicom Format	Hex					
Reserved	31153-31154	0x0480-0x0481	DWord	Float	0		
Reserved	31155-31156	0x0482-0x0483	DWord	Float	0		
Reserved	31157-31158	0x0484-0x0485	DWord	Float	0		
Reserved	31159-31160	0x0486-0x0487	DWord	Float	0		
Reserved	31161-31162	0x0488-0x0489	DWord	Float	0		
Reserved	31163-31164	0x048A-0x048B	DWord	Float	0		
Reserved	31165-31166	0x048C-0x048D	DWord	Float	0		
Reserved	31167-31168	0x048E-0x048F	DWord	Float	0		
Reserved	31169-31170	0x0490-0x0491	DWord	Float	0		
Reserved	31171-31172	0x0492-0x0493	DWord	Float	0		
Reserved	31173-31174	0x0494-0x0495	DWord	Float	0		
Reserved	31175-31176	0x0496-0x0497	DWord	Float	0		
Reserved	31177-31178	0x0498-0x0499	DWord	Float	0		
Reserved	31179-31180	0x049A-0x049B	DWord	Float	0		
Reserved	31181-31182	0x049C-0x049D	DWord	Float	0		
kWh_total	31183-31184	0x049E-0x049F	DWord	Float			
Reserved	31185-31186	0x04A0-0x04A1	DWord	Float	0		
kvarh_total	31187-31188	0x04A2-0x04A3	DWord	Float			
Reserved	31189-31190	0x04A4-0x04A5	DWord	Float	0		
kVAh_total	31191-31192	0x04A6-0x04A7	DWord	Float			

**Modbus Module #20 Input Register : Phase A Voltage Harmonics(僅進階版)**

Parameter name	Modbus Register		Len	Data Type	Range	Default value	Units	Comment
	Modicom Format	Hex						
Reserved	35633-35634	0x1600-0x1601	DWord	Float				
HD1_V_a	35635-35636	0x1602-0x1603	DWord	Float				
HD2_V_a	35637-35638	0x1604-0x1605	DWord	Float				
HD3_V_a	35639-35640	0x1606-0x1607	DWord	Float				
HD4_V_a	35641-35642	0x1608-0x1609	DWord	Float				
HD5_V_a	35643-35644	0x160A-0x160B	DWord	Float				



HD6_V_a	35645-35646	0x160C-0x160D	DWord	Float				
HD7_V_a	35647-35648	0x160E-0x160F	DWord	Float				
HD8_V_a	35649-35650	0x1610-0x1611	DWord	Float				
HD9_V_a	35651-35652	0x1612-0x1613	DWord	Float				
HD10_V_a	35653-35654	0x1614-0x1615	DWord	Float				
HD11_V_a	35655-35656	0x1616-0x1617	DWord	Float				
HD12_V_a	35657-35658	0x1618-0x1619	DWord	Float				
HD13_V_a	35659-35660	0x161A-0x161B	DWord	Float				
HD14_V_a	35661-35662	0x161C-0x161D	DWord	Float				
HD15_V_a	35663-35664	0x161E-0x161F	DWord	Float				
HD16_V_a	35665-35666	0x1620-0x1621	DWord	Float				
HD17_V_a	35667-35668	0x1622-0x1623	DWord	Float				
HD18_V_a	35669-35670	0x1624-0x1625	DWord	Float				
HD19_V_a	35671-35672	0x1626-0x1627	DWord	Float				
HD20_V_a	35673-35674	0x1628-0x1629	DWord	Float				
HD21_V_a	35675-35676	0x162A-0x162B	DWord	Float				
HD22_V_a	35677-35678	0x162C-0x162D	DWord	Float				
HD23_V_a	35679-35680	0x162E-0x162F	DWord	Float				
HD24_V_a	35681-35682	0x1630-0x1631	DWord	Float				
HD25_V_a	35683-35684	0x1632-0x1633	DWord	Float				
HD26_V_a	35685-35686	0x1634-0x1635	DWord	Float				
HD27_V_a	35687-35688	0x1636-0x1637	DWord	Float				
HD28_V_a	35689-35690	0x1638-0x1639	DWord	Float				
HD29_V_a	35691-35692	0x163A-0x163B	DWord	Float				
HD30_V_a	35693-35694	0x163C-0x163D	DWord	Float				
HD31_V_a	35695-35696	0x163E-0x163F	DWord	Float				

**Modbus Module #21 Input Register : Phase B Voltage Harmonics (僅進階版)**

Parameter name	Modbus Register		Len	Data Type	Range	Default value	Units	Comment
	Modicom Format	Hex						
Reserved	35697-35698	0x1640-0x1641	DWord	Float				
HD1_V_b	35699-35700	0x1642-0x1643	DWord	Float				
HD2_V_b	35701-35702	0x1644-0x1645	DWord	Float				
HD3_V_b	35703-35704	0x1646-0x1647	DWord	Float				
HD4_V_b	35705-35706	0x1648-0x1649	DWord	Float				
HD5_V_b	35707-35708	0x164A-0x164B	DWord	Float				

HD6_V_b	35709-35710	0x164C-0x164D	DWord	Float				
HD7_V_b	35711-35712	0x164E-0x164F	DWord	Float				
HD8_V_b	35713-35714	0x1650-0x1651	DWord	Float				
HD9_V_b	35715-35716	0x1652-0x1653	DWord	Float				
HD10_V_b	35717-35718	0x1654-0x1655	DWord	Float				
HD11_V_b	35719-35720	0x1656-0x1657	DWord	Float				
HD12_V_b	35721-35722	0x1658-0x1659	DWord	Float				
HD13_V_b	35723-35724	0x165A-0x165B	DWord	Float				
HD14_V_b	35725-35726	0x165C-0x165D	DWord	Float				
HD15_V_b	35727-35728	0x165E-0x165F	DWord	Float				
HD16_V_b	35729-35730	0x1660-0x1661	DWord	Float				
HD17_V_b	35731-35732	0x1662-0x1663	DWord	Float				
HD18_V_b	35733-35734	0x1664-0x1665	DWord	Float				
HD19_V_b	35735-35736	0x1666-0x1667	DWord	Float				
HD20_V_b	35737-35738	0x1668-0x1669	DWord	Float				
HD21_V_b	35739-35740	0x166A-0x166B	DWord	Float				
HD22_V_b	35741-35742	0x166C-0x166D	DWord	Float				
HD23_V_b	35743-35744	0x166E-0x166F	DWord	Float				
HD24_V_b	35745-35746	0x1670-0x1671	DWord	Float				
HD25_V_b	35747-35748	0x1672-0x1673	DWord	Float				
HD26_V_b	35749-35750	0x1674-0x1675	DWord	Float				
HD27_V_b	35751-35752	0x1676-0x1677	DWord	Float				
HD28_V_b	35753-35754	0x1678-0x1679	DWord	Float				
HD29_V_b	35755-35756	0x167A-0x167B	DWord	Float				
HD30_V_b	35757-35758	0x167C-0x167D	DWord	Float				
HD31_V_b	35759-35760	0x167E-0x167F	DWord	Float				

**Modbus Module #22 Input Register : Phase C Voltage Harmonics (僅進階版)**

Parameter name	Modbus Register		Len	Data Type	Range	Default value	Units	Comment
	Modicom Format	Hex						
Reserved	35761-35762	0x1680-0x1681	DWord	Float				
HD1_V_c	35763-35764	0x1682-0x1683	DWord	Float				
HD2_V_c	35765-35766	0x1684-0x1685	DWord	Float				
HD3_V_c	35767-35768	0x1686-0x1687	DWord	Float				
HD4_V_c	35769-35770	0x1688-0x1689	DWord	Float				
HD5_V_c	35771-35772	0x168A-0x168B	DWord	Float				

HD6_V_c	35773-35774	0x168C-0x168D	DWord	Float				
HD7_V_c	35775-35776	0x168E-0x168F	DWord	Float				
HD8_V_c	35777-35778	0x1690-0x1691	DWord	Float				
HD9_V_c	35779-35780	0x1692-0x1693	DWord	Float				
HD10_V_c	35781-35782	0x1694-0x1695	DWord	Float				
HD11_V_c	35783-35784	0x1696-0x1697	DWord	Float				
HD12_V_c	35785-35786	0x1698-0x1699	DWord	Float				
HD13_V_c	35787-35788	0x169A-0x169B	DWord	Float				
HD14_V_c	35789-35790	0x169C-0x169D	DWord	Float				
HD15_V_c	35791-35792	0x169E-0x169F	DWord	Float				
HD16_V_c	35793-35794	0x16A0-0x16A1	DWord	Float				
HD17_V_c	35795-35796	0x16A2-0x16A3	DWord	Float				
HD18_V_c	35797-35798	0x16A4-0x16A5	DWord	Float				
HD19_V_c	35799-35800	0x16A6-0x16A7	DWord	Float				
HD20_V_c	35801-35802	0x16A8-0x16A9	DWord	Float				
HD21_V_c	35803-35804	0x16AA-0x16AB	DWord	Float				
HD22_V_c	35805-35806	0x16AC-0x16AD	DWord	Float				
HD23_V_c	35807-35808	0x16AE-0x16AF	DWord	Float				
HD24_V_c	35809-35810	0x16B0-0x16B1	DWord	Float				
HD25_V_c	35811-35812	0x16B2-0x16B3	DWord	Float				
HD26_V_c	35813-35814	0x16B4-0x16B5	DWord	Float				
HD27_V_c	35815-35816	0x16B6-0x16B7	DWord	Float				
HD28_V_c	35817-35818	0x16B8-0x16B9	DWord	Float				
HD29_V_c	35819-35820	0x16BA-0x16BB	DWord	Float				
HD30_V_c	35821-35822	0x16BC-0x16BD	DWord	Float				
HD31_V_c	35823-35824	0x16BE-0x16BF	DWord	Float				

**Modbus Module #23 Input Register : Phase A Current Harmonics (僅進階版)**

Parameter name	Modbus Register		Len	Data Type	Range	Default value	Units	Comment
	Modicom Format	Hex						
Reserved	35825-35826	0x16C0-0x16C1	DWord	Float				
HD1_I_a	35827-35828	0x16C2-0x16C3	DWord	Float				
HD2_I_a	35829-35830	0x16C4-0x16C5	DWord	Float				
HD3_I_a	35831-35832	0x16C6-0x16C7	DWord	Float				
HD4_I_a	35833-35834	0x16C8-0x16C9	DWord	Float				
HD5_I_a	35835-35836	0x16CA-0x16CB	DWord	Float				

HD6_I_a	35837-35838	0x16CC-0x16CD	DWord	Float				
HD7_I_a	35839-35840	0x16CE-0x16CF	DWord	Float				
HD8_I_a	35841-35842	0x16D0-0x16D1	DWord	Float				
HD9_I_a	35843-35844	0x16D2-0x16D3	DWord	Float				
HD10_I_a	35845-35846	0x16D4-0x16D5	DWord	Float				
HD11_I_a	35847-35848	0x16D6-0x16D7	DWord	Float				
HD12_I_a	35849-35850	0x16D8-0x16D9	DWord	Float				
HD13_I_a	35851-35852	0x16DA-0x16DB	DWord	Float				
HD14_I_a	35853-35854	0x16DC-0x16DD	DWord	Float				
HD15_I_a	35855-35856	0x16DE-0x16DF	DWord	Float				
HD16_I_a	35857-35858	0x16E0-0x16E1	DWord	Float				
HD17_I_a	35859-35860	0x16E2-0x16E3	DWord	Float				
HD18_I_a	35861-35862	0x16E4-0x16E5	DWord	Float				
HD19_I_a	35863-35864	0x16E6-0x16E7	DWord	Float				
HD20_I_a	35865-35866	0x16E8-0x16E9	DWord	Float				
HD21_I_a	35867-35868	0x16EA-0x16EB	DWord	Float				
HD22_I_a	35869-35870	0x16EC-0x16ED	DWord	Float				
HD23_I_a	35871-35872	0x16EE-0x16EF	DWord	Float				
HD24_I_a	35873-35874	0x16F0-0x16F1	DWord	Float				
HD25_I_a	35875-35876	0x16F2-0x16F3	DWord	Float				
HD26_I_a	35877-35878	0x16F4-0x16F5	DWord	Float				
HD27_I_a	35879-35880	0x16F6-0x16F7	DWord	Float				
HD28_I_a	35881-35882	0x16F8-0x16F9	DWord	Float				
HD29_I_a	35883-35884	0x16FA-0x16FB	DWord	Float				
HD30_I_a	35885-35886	0x16FC-0x16FD	DWord	Float				
HD31_I_a	35887-35888	0x16FE-0x16FF	DWord	Float				

**Modbus Module #24 Input Register : Phase B Current Harmonics (僅進階版)**

Parameter name	Modbus Register		Len	Data Type	Range	Default value	Units	Comment
	Modicom Format	Hex						
Reserved	35889-35890	0x1700-0x1701	DWord	Float				
HD1_I_b	35891-35892	0x1702-0x1703	DWord	Float				
HD2_I_b	35893-35894	0x1704-0x1705	DWord	Float				
HD3_I_b	35895-35896	0x1706-0x1707	DWord	Float				
HD4_I_b	35897-35898	0x1708-0x1709	DWord	Float				
HD5_I_b	35899-35900	0x170A-0x170B	DWord	Float				

HD6_I_b	35901-35902	0x170C-0x170D	DWord	Float				
HD7_I_b	35903-35904	0x170E-0x170F	DWord	Float				
HD8_I_b	35905-35906	0x1710-0x1711	DWord	Float				
HD9_I_b	35907-35908	0x1712-0x1713	DWord	Float				
HD10_I_b	35909-35910	0x1714-0x1715	DWord	Float				
HD11_I_b	35911-35912	0x1716-0x1717	DWord	Float				
HD12_I_b	35913-35914	0x1718-0x1719	DWord	Float				
HD13_I_b	35915-35916	0x171A-0x171B	DWord	Float				
HD14_I_b	35917-35918	0x171C-0x171D	DWord	Float				
HD15_I_b	35919-35920	0x171E-0x171F	DWord	Float				
HD16_I_b	35921-35922	0x1720-0x1721	DWord	Float				
HD17_I_b	35923-35924	0x1722-0x1723	DWord	Float				
HD18_I_b	35925-35926	0x1724-0x1725	DWord	Float				
HD19_I_b	35927-35928	0x1726-0x1727	DWord	Float				
HD20_I_b	35929-35930	0x1728-0x1729	DWord	Float				
HD21_I_b	35931-35932	0x172A-0x172B	DWord	Float				
HD22_I_b	35933-35934	0x172C-0x172D	DWord	Float				
HD23_I_b	35935-35936	0x172E-0x172F	DWord	Float				
HD24_I_b	35937-35938	0x1730-0x1731	DWord	Float				
HD25_I_b	35939-35940	0x1732-0x1733	DWord	Float				
HD26_I_b	35941-35942	0x1734-0x1735	DWord	Float				
HD27_I_b	35943-35944	0x1736-0x1737	DWord	Float				
HD28_I_b	35945-35946	0x1738-0x1739	DWord	Float				
HD29_I_b	35947-35948	0x173A-0x173B	DWord	Float				
HD30_I_b	35949-35950	0x173C-0x173D	DWord	Float				
HD31_I_b	35951-35952	0x173E-0x173F	DWord	Float				

**Modbus Module #25 Input Register : Phase C Current Harmonics (僅進階版)**

Parameter name	Modbus Register		Len	Data Type	Range	Default value	Units	Comment
	Modicom Format	Hex						
Reserved	35953-35954	0x1740-0x1741	DWord	Float				
HD1_I_c	35955-35956	0x1742-0x1743	DWord	Float				
HD2_I_c	35957-35958	0x1744-0x1745	DWord	Float				
HD3_I_c	35959-35960	0x1746-0x1747	DWord	Float				
HD4_I_c	35961-35962	0x1748-0x1749	DWord	Float				
HD5_I_c	35963-35964	0x174A-0x174B	DWord	Float				

HD6_I_c	35965-35966	0x174C-0x174D	DWord	Float				
HD7_I_c	35967-35968	0x174E-0x174F	DWord	Float				
HD8_I_c	35969-35970	0x1750-0x1751	DWord	Float				
HD9_I_c	35971-35972	0x1752-0x1753	DWord	Float				
HD10_I_c	35973-35974	0x1754-0x1755	DWord	Float				
HD11_I_c	35975-35976	0x1756-0x1757	DWord	Float				
HD12_I_c	35977-35978	0x1758-0x1759	DWord	Float				
HD13_I_c	35979-35980	0x175A-0x175B	DWord	Float				
HD14_I_c	35981-35982	0x175C-0x175D	DWord	Float				
HD15_I_c	35983-35984	0x175E-0x175F	DWord	Float				
HD16_I_c	35985-35986	0x1760-0x1761	DWord	Float				
HD17_I_c	35987-35988	0x1762-0x1763	DWord	Float				
HD18_I_c	35989-35990	0x1764-0x1765	DWord	Float				
HD19_I_c	35991-35992	0x1766-0x1767	DWord	Float				
HD20_I_c	35993-35994	0x1768-0x1769	DWord	Float				
HD21_I_c	35995-35996	0x176A-0x176B	DWord	Float				
HD22_I_c	35997-35998	0x176C-0x176D	DWord	Float				
HD23_I_c	35999-36000	0x176E-0x176F	DWord	Float				
HD24_I_c	36001-36002	0x1770-0x1771	DWord	Float				
HD25_I_c	36003-36004	0x1772-0x1773	DWord	Float				
HD26_I_c	36005-36006	0x1774-0x1775	DWord	Float				
HD27_I_c	36007-36008	0x1776-0x1777	DWord	Float				
HD28_I_c	36009-36010	0x1778-0x1779	DWord	Float				
HD29_I_c	36011-36012	0x177A-0x177B	DWord	Float				
HD30_I_c	36013-36014	0x177C-0x177D	DWord	Float				
HD31_I_c	36015-36016	0x177E-0x177F	DWord	Float				